

MARINE AND OFFSHORE CABLES

**POWER AND
CONTROL CABLES**

**CONTROL AND
INSTRUMENTATION CABLES**

FIRE-RESISTANT CABLES

OPTICAL FIBER CABLES

DATA CABLES



HELKAMA

THE PERFECT CONNECTION

HELKAMA | MARINE

Follow the lead.

From design to manufacturing.

Helkama Bica Oy is a Finnish family enterprise with over half a century of experience in the development and production of Marine and Telecom cables. We have continuously grown our business and developed our in-house expertise. Working with the biggest partners in the marine sector for many years, we have learned to operate fluently on an international level. And we share that level effortlessly with huge and rigid cable manufacturer giants. But, we have a significant advantage to the others: we are flexible and able to react fast to changing project schedules and customer needs. No matter how big or small the project.

Helkama Marine and offshore cable catalogue shows off our comprehensive range of marine cables. All of our marine cables are halogen-free to meet the high requirements of safety on board. Halogen-free cables do not emit toxic burning fumes or thick smoke, and therefore remarkably improve the fire safety of the ships.

Using the latest technology, and the brains of our in-house R&D department, we have been able to reduce cable weight and size to a minimum and still maintain the same exquisite Helkama quality! Low weight and smaller diameters equal savings in both installation times and related installation materials. And just like us, our cables are flexible, top quality and will remain reliable even when things heat up.

The halogen free range of cables includes both flame-retardant (IEC 60332-3) and fire resistant (IEC 60331-series, EN 50200 and BS 8491) cables. Helkama marine cables are also approved by all major classification societies.

Our high technical quality has been achieved by not only continuous development work, but by working closely together with our clients. And our focus is seriously on service. Or rather, we are serious when it comes to service. Our sales team is there to help with Your project from the design phase all the way to the cables arriving on time for the assembly crew on-site.

We ship yearly to over 60 countries, to more than 1000 active customers. Our short delivery times backed up by extensive stocks enable us to deliver punctually, giving our clients better project schedule control. As a result, there are over 2000 ships cruising around the globe running on Helkama cables!

So follow the lead, and get the best cabling solution for Your marine projects from Helkama!



Contents

0.6/1 kV CABLES

LKM-HF.....	4
LKSM-HF.....	8
LKSM-EMC.....	12
LKAM-HF.....	16
LKMM-HF.....	18
LKMSM-HF.....	20
LKEM-HF.....	22
LKM-FRHF.....	24
LKM-FRHF+WSR/WJR.....	28
LKSM-FRHF.....	32
LKSM-FRHF+WSR/WJR.....	36
LKSM-EMC-FRHF.....	40
LKAM-FRHF.....	44

1.8/3 kV CABLES

LKSM-VFD.....	46
---------------	----

150/250 V CABLES

LKM-HF.....	48
LKSM-HF.....	50
LKAM-HF.....	52
LKM-FRHF.....	54
LKSM-FRHF.....	56
LKAM-FRHF.....	58

RFE-HF.....	60
RFE-HF (i).....	62
RFE-EMC.....	64
RFE-EMC (i).....	66
RFA-HF.....	68
RFA-HF (i).....	70
RFE-FRHF.....	72
RFE-FRHF (i).....	74
RFE-EMC-FRHF.....	76
RFE-EMC-FRHF (i).....	78
RFA-FRHF.....	80
RFA-FRHF (i).....	82
RFE-FRHF+WSR/WJR.....	84
RFE-FRHF (i)+WSR/WJR.....	86
RFA-FRHF+WSR/WJR.....	88
RFA-FRHF (i)+WSR/WJR.....	90

OPTICAL FIBER CABLES

FXMSU.....	92
FXMMS.....	94
FXVDMSU.....	96
LifeCord-FRHF (f).....	98
Optical fiber cable characteristics.....	100
Fiber colouring.....	102

DATA CABLES

CAT7 S/FTP AWG23/1.....	104
CAT7 S/FTP AWG 26/7.....	106
CAT7 S/FTP AWG24/7.....	108
CAN-BUS 1x2x0,75.....	110
CAN-BUS 2x2x0,75.....	111
PROFIBUS DP 1x2xAWG22/7.....	112

TECHNICAL INFORMATION

General information.....	114
Bending radius.....	116
Diameter tolerance.....	116
Core identification.....	116
Current rating.....	117
Short circuit current.....	118
Short circuit factor.....	118
Rated voltages.....	118
Test voltages.....	119
Short time duty.....	120
Intermittent service.....	120
Voltage drop.....	121
PE rules.....	122



Up to date information on type approvals can be found on our website helkamabica.com
If there is a Type Approval Certificate missing from the list, do not hesitate to contact us.

LKM-HF

0.6/1 kV

Unarmoured power and control cable

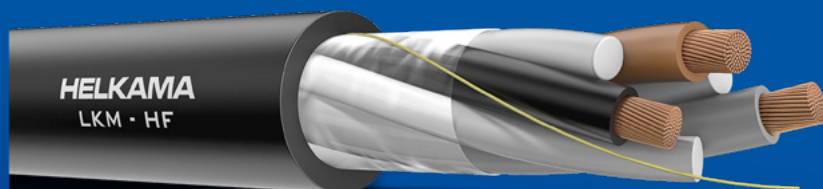

- Flame-retardant • Halogen-free • Low smoke emission • Oil resistant (SHF2 only)

CONDUCTOR	Stranded copper conductor 1.0-10 mm ² , IEC 60228 Class 2 Stranded copper conductor 16-300 mm ² , IEC 60228 Class 5
INSULATION	XLPE
CABLING	Cores twisted together, with optional fillers or dummy cores to obtain symmetrical and round construction, covered by separator tape
RIP CORD	For conductors ≥ 16 mm ²
SHEATH	Polyolefine SHF1, IEC 60092-360 Thermosetting polyolefine SHF2 on request Standard colour black, other colours on request
REFERENCE STANDARD	IEC 60092-353

APPLICATION

Unarmoured power and control cable. For fixed installation in most areas, and on open deck in ships and offshore units.

PHYSICAL PROPERTIES:

CORE IDENTIFICATION	Colour code for 1...4 core cables, number code for 5...37 core cables
MARINE TYPE APPROVALS	ABS, BV, CCS, CRS, DNV, KR, LR, RINA

MAIN CHARACTERISTICS:

RATED VOLTAGE	AC 0.6/1 kV (1.2 kV) DC 0.9/1.5 kV (if voltage to earth does not exceed 0.9 kV)
FIRE PERFORMANCE	IEC 60332-1-2 IEC 60332-3-22
HALOGEN-FREE	IEC 60754 series
SMOKE EMISSION	IEC 61034 series
OIL RESISTANCE (SHF2 only)	IEC 60811-404 conditions according to 60092-360/SHF2
MIN. INSTALLATION TEMPERATURE	-15 °C
OPERATING TEMPERATURE	-40 – 80 °C fixed installation
MAXIMUM CONDUCTOR TEMPERATURE	90 °C

Subject to change without prior notice. See latest update on our webpage.

© 2022 Helkama Bica Oy. All rights reserved.

LKM-HF 0.6/1 kV

Part number	G-type	No. of conductors x Conductor area (mm ²)	Nominal outer Ø (mm)	Weight kg/km	Current rating A	Min. bending radius mm (fixed)
25580	-	1 x 1.0	5.0	35	18	25
25636	28396	1 x 1.5	5.5	40	23	25
25638	27000	1 x 2.5	5.5	55	30	25
25640	27002	1 x 4	6.5	70	40	30
25642	27004	1 x 6	7.0	95	52	30
25644	27006	1 x 10	8.0	140	72	35
25647	27009	1 x 16 cl5	9.0	190	94	40
25649	27011	1 x 25 cl5	11.5	290	123	50
25651	27013	1 x 35 cl5	12.5	385	153	50
25653	27015	1 x 50 cl5	14.5	530	196	60
25655	27017	1 x 70 cl5	16.5	740	240	70
25657	27019	1 x 95 cl5	18.0	955	284	75
25659	27021	1 x 120 cl5	20.0	1200	331	85
25661	27023	1 x 150 cl5	23.0	1515	381	95
25663	27025	1 x 185 cl5	25.5	1840	429	155
25665	27027	1 x 240 cl5	28.5	2445	507	175
26047	27029	1 x 300 cl5	31.5	3015	582	190
25581	-	2 x 1.0	8.0	65	15	35
25670	-	2 x 1.5	8.5	80	20	35
25686	-	2 x 2.5	9.5	115	26	40
25702	-	2 x 4	10.5	155	34	45
25701	-	2 x 6	12.0	240	44	50
25717	-	2 x 10	14.0	360	61	60
26054	-	2 x 16 cl5	17.0	515	80	70
26055	-	2 x 25 cl5	21.0	790	105	85
26056	-	2 x 35 cl5	23.0	1045	130	95
26057	-	2 x 50 cl5	26.5	1445	167	165
26058	-	2 x 70 cl5	31.0	1985	204	190
26059	-	2 x 95 cl5	34.5	2630	241	210
25582	28957	3 x 1.0	8.0	85	13	35
25671	25672	3 x 1.5	9.0	100	16	40
25688	25689	3 x 2.5	10.0	145	21	45
25703	25704	3 x 4	11.5	200	28	50
25705	25706	3 x 6	13.0	310	36	55
25707	25708	3 x 10	15.0	465	50	65
26071	26072	3 x 16 cl5	18.0	650	66	75
26073	26074	3 x 25 cl5	22.5	1005	86	90
26075	26076	3 x 35 cl5	24.5	1320	107	100
26077	26078	3 x 50 cl5	29.0	1860	137	175
26079	26080	3 x 70 cl5	33.5	2605	168	205
26081	26082	3 x 95 cl5	37.0	3375	199	225
26083	26085	3 x 120 cl5	42.0	4290	232	255
26084	26086	3 x 150 cl5	48.0	5410	267	290
26087	26088	3 x 185 cl5	53.0	6635	300	320
26089	26090	3 x 240 cl5	60.0	8775	355	360
26099	26100	3 x 300 cl5	67.0	10960	407	405
25583	28398	4 x 1.0	9.0	100	13	40
25673	25674	4 x 1.5	10.0	135	16	45

Standard length 1000 m

G-type with yellow/green earth conductor and G-marking on sheath e.g. 3G1.5

SHF2 on request. Part number for SHF2 cables 4 + code from above table → 4xxxxx

Table continues on next page

LKM-HF 0.6/1 kV

Part number	G-type	No. of conductors x Conductor area (mm ²)	Nominal outer Ø (mm)	Weight kg/km	Current rating A	Min. bending radius mm (fixed)
25690	25691	4 x 2.5	11.0	180	21	45
25725	25726	4 x 4	12.5	260	28	55
25727	25728	4 x 6	14.0	385	36	60
25729	25730	4 x 10	16.5	585	50	70
26101	26102	4 x 16 cl5	20.0	820	66	80
26103	26104	4 x 25 cl5	25.0	1265	86	155
26105	26106	4 x 35 cl5	27.0	1690	107	165
26107	26108	4 x 50 cl5	32.0	2390	137	195
26109	26110	4 x 70 cl5	37.0	3315	168	225
26111	26112	4 x 95 cl5	41.5	4320	199	250
26113	26114	4 x 120 cl5	46.5	5450	232	280
26115	26116	4 x 150 cl5	53.5	6915	267	325
26117	26118	4 x 185 cl5	59.0	8470	300	355
25584	28399	5 x 1.0	10.0	135	10	45
25676	25677	5 x 1.5	11.0	165	13	45
25692	25693	5 x 2.5	12.0	220	17	50
25864	25865	5 x 4	13.5	320	23	55
25866	25867	5 x 6	15.5	480	30	65
25868	25869	5 x 10	18.5	725	42	75
26131	26132	5 x 16 cl5	22.0	1000	55	90
26133	26134	5 x 25 cl5	27.5	1575	71	170
26135	26136	5 x 35 cl5	30.0	2115	89	185
26137	26138	5 x 50 cl5	35.5	2960	114	215
26139	26140	5 x 70 cl5	41.5	4160	139	250
26145	26146	5 x 95 cl5	46.0	5440	165	280
25585	28400	7 x 1.0	11.0	160	9	45
25586	28401	10 x 1.0	14.0	235	8	60
25587	28402	12 x 1.0	14.5	260	8	60
25588	28403	14 x 1.0	15.0	295	7	65
25589	28404	16 x 1.0	16.0	335	7	65
25590	28405	19 x 1.0	17.0	380	7	70
25592	28407	24 x 1.0	20.0	485	6	80
25593	28408	27 x 1.0	20.5	530	6	85
25597	28409	30 x 1.0	21.0	575	5	85
25595	28411	37 x 1.0	23.0	705	5	95
25678	25679	7 x 1.5	12.0	205	12	50
25667	25668	10 x 1.5	15.0	295	11	65
25680	25681	12 x 1.5	15.5	340	10	65
25991	25992	14 x 1.5	16.5	385	10	70
25989	25990	16 x 1.5	17.5	435	9	70
25682	25683	19 x 1.5	18.5	500	9	75
25875	25876	24 x 1.5	22.0	640	8	90
25684	25685	27 x 1.5	22.5	700	8	90
-	-	30 x 1.5	23.0	765	7	95
25675	25687	37 x 1.5	25.0	925	7	155
25694	25695	7 x 2.5	13.5	285	16	55
25993	25994	10 x 2.5	17.0	410	14	70
25696	25874	12 x 2.5	17.5	465	13	75

Standard length 1000 m

Table continues on next page

G-type with yellow/green earth conductor and G-marking on sheath e.g. 3G1.5

SHF2 on request. Part number for SHF2 cables 4 + code from above table → 4xxxxx

LKM-HF 0.6/1 kV

Part number	G-type	No. of conductors x Conductor area (mm ²)	Nominal outer Ø (mm)	Weight kg/km	Current rating A	Min. bending radius mm (fixed)
25995	25996	14 x 2.5	18.5	540	13	75
25997	25998	16 x 2.5	19.5	610	12	80
25873	25872	19 x 2.5	20.5	690	11	85
25877	25878	24 x 2.5	24.5	900	10	100
26141	26142	27 x 2.5	25.5	990	10	155
-	-	30 x 2.5	26.0	1085	10	160
26143	26144	37 x 2.5	28.5	1310	9	175

Standard length 1000 m

G-type with yellow/green earth conductor and G-marking on sheath e.g. 3G1.5

SHF2 on request. Part number for SHF2 cables 4 + code from above table → 4xxxxx

Other sizes on request.

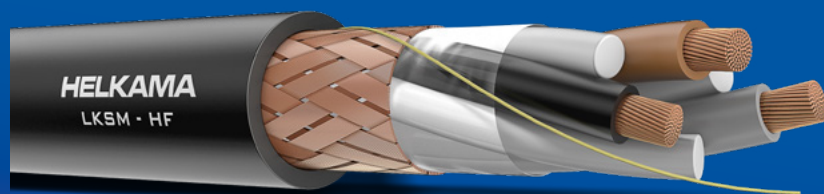

Photo credit/copyright: Helkama Bica Oy

LKSM-HF

0.6/1 kV

Armoured power and control cable



- Flame-retardant • Halogen-free • Low smoke emission • Oil resistant (SHF2 only)

CONDUCTOR	Stranded copper conductor 1.0-10 mm ² , IEC 60228 Class 2 Stranded copper conductor 16-300 mm ² , IEC 60228 Class 5
INSULATION	XLPE
CABLING/BEDDING	Cabling, cores twisted together, with optional fillers or dummy cores for symmetrical and round construction. Bedding, lapped tape.
ARMOUR	Copper wire braid, coverage > 90%, IEC 60092-350 Tinned copper wire braid on request
RIP CORD	For conductors ≥ 16 mm ²
SHEATH	Polyolefine SHF1, IEC 60092-360 Thermosetting polyolefine SHF2 on request Standard colour black, other colours on request
REFERENCE STANDARD	IEC 60092-353

APPLICATION

Armoured power and control cable. For fixed installation in most areas, and on open deck in ships and offshore units.

PHYSICAL PROPERTIES:

CORE IDENTIFICATION	Colour code for 1...4 core cables, number code for 5...37 core cables
MARINE TYPE APPROVALS	ABS, BV, CCS, CRS, DNV, KR, LR, RINA

MAIN CHARACTERISTICS:

RATED VOLTAGE	AC 0.6/1 kV (1.2 kV) DC 0.9/1.5 kV (if voltage to earth does not exceed 0.9 kV)
FIRE PERFORMANCE	IEC 60332-1-2 IEC 60332-3-22
HALOGEN-FREE	IEC 60754 series
SMOKE EMISSION	IEC 61034 series
OIL RESISTANCE (SHF2 only)	IEC 60811-404 conditions according to 60092-360/SHF2
MIN. INSTALLATION TEMPERATURE	-15 °C
OPERATING TEMPERATURE	-40 - 80 °C fixed installation
MAXIMUM CONDUCTOR TEMPERATURE	90 °C

Subject to change without prior notice. See latest update on our webpage.

© 2022 Helkama Bica Oy. All rights reserved.

LKSM-HF 0.6/1 kV

Part number	G-type	No. of conductors x Conductor area (mm ²)	Cross-section of armour mm ²	Nominal outer Ø (mm)	Weight kg/km	Current rating A	Min. bending radius mm (fixed)
25955	28425	1 x 1.0	3.0	6.0	70	18	40
25736	28426	1 x 1.5	3.0	6.5	75	23	40
25738	27050	1 x 2.5	2.5	7.0	85	30	45
25740	27052	1 x 4	3.1	7.5	110	40	45
25742	27054	1 x 6	3.1	8.0	130	52	50
25744	27056	1 x 10	3.6	9.5	190	72	60
26237	27059	1 x 16 cl5	4.1	10.5	240	94	65
26238	27061	1 x 25 cl5	4.9	13.0	360	123	80
26239	27063	1 x 35 cl5	5.5	14.0	455	153	85
26240	27065	1 x 50 cl5	8.7	16.0	640	196	100
26241	27067	1 x 70 cl5	10.0	18.5	865	240	115
26242	27069	1 x 95 cl5	11.5	20.0	1090	284	125
26243	27071	1 x 120 cl5	12.3	22.5	1360	331	135
26244	27073	1 x 150 cl5	13.7	25.0	1685	381	155
26245	27075	1 x 185 cl5	15.2	27.0	2020	429	165
26246	27077	1 x 240 cl5	18.2	30.5	2655	507	185
26247	27079	1 x 300 cl5	18.7	34.0	3250	582	205
25956	-	2 x 1.0	3.6	9.0	110	15	55
25770	-	2 x 1.5	3.8	9.5	130	20	60
25785	-	2 x 2.5	4.3	10.5	160	26	65
25801	-	2 x 4	5.2	12.0	215	34	75
25803	-	2 x 6	5.4	13.0	320	44	80
25805	-	2 x 10	8.7	15.5	480	61	95
26254	-	2 x 16 cl5	10.0	18.0	635	80	110
26255	-	2 x 25 cl5	12.3	23.0	965	105	140
26256	-	2 x 35 cl5	14.0	24.5	1230	130	150
26257	-	2 x 50 cl5	16.3	28.5	1655	167	175
26258	-	2 x 70 cl5	18.7	33.0	2245	204	200
26259	-	2 x 95 cl5	21.2	36.5	2890	241	220
25957	-	3 x 1.0	3.7	9.5	130	13	60
25772	25773	3 x 1.5	4.1	10.0	155	16	65
25786	25787	3 x 2.5	5.2	11.0	200	21	70
25802	25880	3 x 4	5.3	12.5	265	28	80
25804	25882	3 x 6	5.8	14.0	375	36	85
25806	25884	3 x 10	9.3	16.5	575	50	100
26271	26272	3 x 16 cl5	10.7	19.0	770	66	115
26273	26274	3 x 25 cl5	13.2	24.5	1185	86	150
26275	26276	3 x 35 cl5	15.0	26.0	1510	107	160
26277	26278	3 x 50 cl5	17.5	30.5	2095	137	185
26279	26280	3 x 70 cl5	20.2	35.5	2860	168	215
26281	26282	3 x 95 cl5	22.8	39.0	3660	199	235
26283	26284	3 x 120 cl5	35.1	44.0	4705	232	265
26285	26286	3 x 150 cl5	39.3	50.0	5885	267	305
26287	26288	3 x 185 cl5	43.4	55.0	7160	300	335
26295	26296	3 x 240 cl5	50.7	62.0	9385	355	375
25958	-	4 x 1.0	4.1	10.0	150	13	65
25774	25775	4 x 1.5	4.5	11.0	185	16	70
25788	25789	4 x 2.5	5.3	12.5	240	21	75

Standard length 1000 m

G-type with yellow/green earth conductor and G-marking on sheath e.g. 3G1.5 SHF2 on request. Part number for SHF2 cables 4 + code from above table → 4xxxxx

Table continues on next page

LKSM-HF 0.6/1 kV

Part number	G-type	No. of conductors x Conductor area (mm ²)	Cross-section of armour mm ²	Nominal outer Ø (mm)	Weight kg/km	Current rating A	Min. bending radius mm (fixed)
25830	25831	4 x 4	5.7	13.5	320	28	85
25832	25833	4 x 6	8.8	15.5	480	36	95
25834	25835	4 x 10	10.3	18.0	700	50	110
26301	26302	4 x 16 cl5	11.9	21.5	945	66	130
26303	26304	4 x 25 cl5	14.8	27.0	1425	86	165
26305	26306	4 x 35 cl5	16.7	29.0	1850	107	175
26307	26308	4 x 50 cl5	19.5	34.0	2560	137	205
26309	26310	4 x 70 cl5	22.6	39.0	3495	168	235
26311	26312	4 x 95 cl5	35.0	44.0	4615	199	265
26313	26314	4 x 120 cl5	39.3	49.0	5765	232	295
26315	26316	4 x 150 cl5	44.0	55.5	7240	267	335
26317	26318	4 x 185 cl5	48.9	61.5	8810	300	370
25959	-	5 x 1.0	4.5	10.5	180	10	65
25776	25777	5 x 1.5	5.0	12.0	225	13	75
25790	25791	5 x 2.5	5.6	13.5	290	17	80
26011	26012	5 x 4	8.6	15.0	420	23	95
26013	26014	5 x 6	9.7	17.0	580	30	105
26015	26016	5 x 10	11.5	20.0	850	42	120
26331	26332	5 x 16 cl5	13.2	23.0	1135	55	140
26333	26334	5 x 25 cl5	16.3	29.5	1740	71	180
26335	26336	5 x 35 cl5	18.6	32.0	2295	89	195
26325	26326	5 x 50 cl5	22.4	37.0	3150	114	225
26327	26328	5 x 70 cl5	34.4	43.5	4445	139	265
26329	26330	5 x 95 cl5	39.3	48.5	5755	165	295
25960	-	7 x 1.0	4.9	11.5	215	9	75
25961	-	10 x 1.0	8.7	15.0	320	8	90
25962	-	12 x 1.0	9.0	15.0	350	8	95
25963	-	14 x 1.0	9.4	16.0	385	7	100
25964	-	16 x 1.0	10.0	17.0	440	7	105
25965	-	19 x 1.0	10.6	17.5	485	7	110
25977	-	24 x 1.0	12.5	20.5	610	6	125
25978	-	27 x 1.0	12.8	21.0	660	6	130
25979	-	30 x 1.0	13.3	21.5	710	5	135
25981	-	37 x 1.0	14.4	23.5	840	5	145
25778	25779	7 x 1.5	5.4	13.0	265	12	80
26025	26026	10 x 1.5	9.6	16.5	400	11	100
25780	25846	12 x 1.5	10.0	17.0	445	10	105
26027	26028	14 x 1.5	10.5	18.0	495	10	110
26030	26029	16 x 1.5	11.1	19.0	550	9	115
25782	25781	19 x 1.5	11.7	19.5	615	9	120
25828	25829	24 x 1.5	13.9	23.5	790	8	140
25783	25847	27 x 1.5	14.1	24.0	855	8	145
26039	-	30 x 1.5	14.7	24.5	925	7	150
25784	25848	37 x 1.5	16.0	26.5	1095	7	160
25792	25793	7 x 2.5	8.5	15.0	380	16	90
26033	26034	10 x 2.5	10.8	18.5	530	14	115
25794	25795	12 x 2.5	11.5	19.0	590	13	115
26035	26036	14 x 2.5	11.8	20.5	675	13	125

Standard length 1000 m

G-type with yellow/green earth conductor and G-marking on sheath e.g. 3G1.5

SHF2 on request. Part number for SHF2 cables 4 + code from above table → 4xxxxx

Table continues on next page

LKSM-HF 0.6/1 kV

Part number	G-type	No. of conductors x Conductor area (mm ²)	Cross-section of armour mm ²	Nominal outer Ø (mm)	Weight kg/km	Current rating A	Min. bending radius mm (fixed)
26037	26038	16 x 2.5	12.5	21.5	755	12	130
25796	25797	19 x 2.5	13.2	22.5	845	11	135
25798	25799	24 x 2.5	15.7	26.0	1070	10	160
25768	25769	27 x 2.5	16.1	27.0	1165	10	165
26040	-	30 x 2.5	16.7	27.5	1265	10	170
25849	25850	37 x 2.5	18.1	30.0	1525	9	185

Standard length 1000 m

G-type with yellow/green earth conductor and G-marking on sheath e.g. 3G1.5

SHF2 on request. Part number for SHF2 cables 4 + code from above table → 4xxxxx

Other sizes on request.

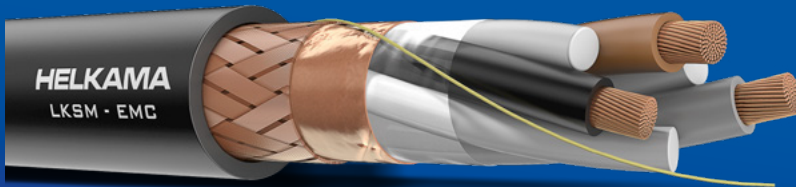

Photo credit: ESL Shipping

LKSM-EMC

0.6/1 kV

Armoured power and control cable
with improved EMC-screening



- Flame-retardant • Halogen-free • Low smoke emission • Oil resistant (SHF2 only)

CONDUCTOR	Stranded copper conductor 1.0-10 mm ² , IEC 60228 Class 2 Stranded copper conductor 16-300 mm ² , IEC 60228 Class 5
INSULATION	XLPE
CABLING/BEDDING	Cabling, cores twisted together, with optional fillers or dummy cores for symmetrical and round construction. Bedding, lapped tape.
SCREEN	Copper tape, coverage 100%
ARMOUR	Copper wire braid, coverage >90%, IEC 60092-350 Tinned copper wire braid on request
RIP CORD	For conductors ≥ 16 mm ²
SHEATH	Polyolefine SHF1, IEC 60092-360 Thermosetting polyolefine SHF2 on request Standard colour black, other colours on request
REFERENCE STANDARD	IEC 60092-353

APPLICATION

Armoured power and control cable. For fixed installation in most areas, and on open deck in ships and offshore units. Specially designed cables with screen for improved screening properties to address EMI/EMC problems.

PHYSICAL PROPERTIES:

CORE IDENTIFICATION	Colour code for 1...4 core cables, number code for 5...37 core cables
MARINE TYPE APPROVALS	ABS, BV, CCS, CRS, DNV, KR, LR, RINA

MAIN CHARACTERISTICS:

RATED VOLTAGE	AC 0.6/1 kV (1.2 kV) DC 0.9/1.5 kV (if voltage to earth does not exceed 0.9 kV)
FIRE PERFORMANCE	IEC 60332-1-2 IEC 60332-3-22
HALOGEN-FREE	IEC 60754 series
SMOKE EMISSION	IEC 61034 series
OIL RESISTANCE (SHF2 only)	IEC 60811-404 conditions according to 60092-360/SHF2
TRANSFER IMPEDANCE	IEC 61196-1 (typical value 26 dB over 1 mΩ/m at 100 MHz [20 mΩ/m])
MIN. INSTALLATION TEMPERATURE	-15 °C
OPERATING TEMPERATURE	-40 - 80 °C fixed installation
MAXIMUM CONDUCTOR TEMPERATURE	90 °C

LKSM-EMC 0.6/1 kV

Part number	G-type	No. of conductors x Conductor area (mm ²)	Cross-section of armour mm ²	Diameter of screen mm	Nominal outer Ø (mm)	Weight kg/km	Current rating A	Min. bending radius mm (fixed)
26904	-	1 x 1.0	3.0	4.0	6.0	80	18	35
27513	-	1 x 1.5	3.0	4.0	6.5	90	23	40
27514	-	1 x 2.5	3.0	4.5	7.0	100	30	40
27515	-	1 x 4	3.1	5.0	7.5	120	40	45
27516	-	1 x 6	3.1	6.0	8.0	145	52	50
27517	-	1 x 10	3.3	7.0	9.5	200	72	55
27518	-	1 x 16 cl5	4.2	8.5	11.0	285	94	65
27519	-	1 x 25 cl5	5.3	10.5	13.5	410	123	80
27520	-	1 x 35 cl5	5.6	11.5	14.0	510	153	85
27521	-	1 x 50 cl5	8.8	13.5	16.5	695	196	100
27522	-	1 x 70 cl5	10.1	15.5	18.5	930	240	110
27523	-	1 x 95 cl5	11.3	17.0	20.5	1160	284	120
27524	-	1 x 120 cl5	12.5	19.0	22.5	1440	331	135
27525	-	1 x 150 cl5	13.9	21.5	25.5	1775	381	150
27526	-	1 x 185 cl5	15.3	23.5	27.5	2120	429	165
27527	-	1 x 240 cl5	17.2	26.5	30.5	2735	507	185
27528	-	1 x 300 cl5	18.9	29.5	34.0	3385	582	205
26905	-	2 x 1.0	3.3	6.5	9.5	130	15	55
27480	-	2 x 1.5	3.6	7.0	10.0	145	20	60
27481	-	2 x 2.5	4.2	8.0	11.0	175	26	65
27482	-	2 x 4	4.6	9.0	12.0	225	34	70
27483	-	2 x 6	5.3	10.5	13.0	340	44	80
27484	-	2 x 10	8.5	12.5	16.0	535	61	95
27485	-	2 x 16 cl5	10.3	15.5	19.0	775	80	115
27486	-	2 x 25 cl5	12.6	19.5	23.5	1125	105	140
27487	-	2 x 35 cl5	14.3	21.0	25.0	1410	130	150
27529	-	2 x 50 cl5	16.6	25.0	29.0	1880	167	175
27530	-	2 x 70 cl5	19.0	29.0	33.5	2530	204	200
27531	-	2 x 95 cl5	21.5	32.0	37.0	3255	241	220
26906	26988	3 x 1.0	3.6	7.0	10.0	155	13	60
26861	26862	3 x 1.5	3.9	7.5	10.5	175	16	60
26863	26864	3 x 2.5	4.3	8.5	11.5	215	21	70
26865	26866	3 x 4	5.3	10.0	12.5	285	28	75
26867	26868	3 x 6	5.6	11.0	14.0	395	36	85
26869	26870	3 x 10	8.9	13.5	16.5	600	50	100
26872	26851	3 x 16 cl5	11.0	17.0	20.0	890	66	120
26874	26852	3 x 25 cl5	13.5	21.0	24.5	1320	86	150
26876	26853	3 x 35 cl5	15.3	23.0	26.5	1650	107	160
26878	26854	3 x 50 cl5	17.8	26.5	31.0	2270	137	185
26880	26855	3 x 70 cl5	20.4	31.0	35.5	3075	168	215
26882	26856	3 x 95 cl5	23.1	34.5	39.5	3910	199	235
26884	26857	3 x 120 cl5	35.5	39.0	44.5	5005	232	265
26886	26858	3 x 150 cl5	39.5	44.5	50.5	6275	267	305
26888	26859	3 x 185 cl5	43.9	49.0	55.5	7585	300	335
26907	26989	4 x 1.0	3.9	8.0	10.5	175	13	65
26942	26943	4 x 1.5	4.3	8.5	11.0	200	16	65
26944	26945	4 x 2.5	4.8	9.5	12.5	260	21	75
26946	26947	4 x 4	5.5	11.0	13.5	340	28	80

Standard length 1000 m

G-type with yellow/green earth conductor and G-marking on sheath e.g. 3G1.5
SHF2 on request. Part number for SHF2 cables 4 + code from above table → 4xxxxx

Table continues on next page

LKSM-EMC 0.6/1 kV

Part number	G-type	No. of conductors x Conductor area (mm ²)	Cross-section of armour mm ²	Diameter of screen mm	Nominal outer Ø (mm)	Weight kg/km	Current rating A	Min. bending radius mm (fixed)
26948	26949	4 x 6	8.5	12.5	15.5	505	36	95
26950	26951	4 x 10	10.0	15.0	18.5	755	50	110
26952	26953	4 x 16 cl5	12.3	18.5	22.0	1045	66	135
26954	26955	4 x 25 cl5	15.0	23.5	27.0	1525	86	165
26956	26957	4 x 35 cl5	17.0	25.5	29.5	1960	107	175
26958	26959	4 x 50 cl5	19.8	29.5	34.5	2695	137	205
26960	26961	4 x 70 cl5	22.8	34.5	39.5	3655	168	235
26962	26963	4 x 95 cl5	35.5	38.5	44.0	4795	199	265
26964	26965	4 x 120 cl5	39.5	43.5	49.5	6000	232	295
26966	26967	4 x 150 cl5	44.1	49.5	56.0	7480	267	335
26908	26990	5 x 1.0	4.3	8.5	11.0	200	10	65
27488	27838	5 x 1.5	5.2	9.5	12.0	245	13	75
27489	27839	5 x 2.5	5.3	10.5	13.5	305	17	80
27490	27940	5 x 4	8.5	12.5	15.5	435	23	90
27491	27941	5 x 6	9.4	14.0	17.0	600	30	100
27492	27942	5 x 10	11.0	16.5	20.0	910	42	120
27493	27943	5 x 16 cl5	13.5	20.5	24.0	1260	55	145
27494	27944	5 x 25 cl5	16.6	26	30.0	1860	71	180
26909	26991	7 x 1.0	4.7	9.5	12.5	245	9	75
26910	26992	10 x 1.0	8.5	12.5	15.5	360	8	95
26911	26993	12 x 1.0	8.6	13.0	16.0	385	8	95
26912	26994	14 x 1.0	9.1	13.5	16.5	420	7	100
26913	26995	16 x 1.0	9.7	14.5	17.5	460	7	105
26914	26996	19 x 1.0	10.2	15.0	18.5	520	7	110
26915	26997	24 x 1.0	12.2	18.0	21.5	700	6	130
26916	26998	27 x 1.0	12.5	18.5	22.0	745	6	130
26917	26999	37 x 1.0	14.0	20.5	24.5	935	5	145
27495	27840	7 x 1.5	5.3	10.0	13.0	290	12	80
27497	27842	10 x 1.5	9.2	13.5	16.5	425	11	100
27499	27844	12 x 1.5	9.6	14.0	17.0	465	10	100
27501	27846	14 x 1.5	10.2	15.0	18.0	520	10	110
27503	27848	16 x 1.5	10.8	15.5	19.0	575	9	115
27505	27850	19 x 1.5	11.5	16.5	20.0	645	9	120
27507	27852	24 x 1.5	13.5	19.5	23.0	855	8	140
27509	27854	27 x 1.5	13.9	20.0	24.0	930	8	145
27511	27856	37 x 1.5	15.7	22.5	26.5	1175	7	160
27496	27841	7 x 2.5	5.9	11.5	14.5	370	16	85
27498	27843	10 x 2.5	10.5	15.5	18.5	550	14	110
27500	27845	12 x 2.5	10.9	16.0	19.0	615	13	115
27502	27847	14 x 2.5	11.5	17.0	20.0	690	12	120
27504	27849	16 x 2.5	12.2	18.0	21.5	785	12	130
27506	27851	19 x 2.5	12.9	19.0	22.5	910	11	135
27508	27853	24 x 2.5	15.4	22.5	26.0	1145	10	155
27510	27855	27 x 2.5	15.8	23.0	27.0	1250	10	160
27512	27857	37 x 2.5	17.8	25.5	30.0	1610	9	180

Standard length 1000 m

G-type with yellow/green earth conductor and G-marking on sheath e.g. 3G1.5

SHF2 on request. Part number for SHF2 cables 4 + code from above table → 4xxxxx

Other sizes on request.

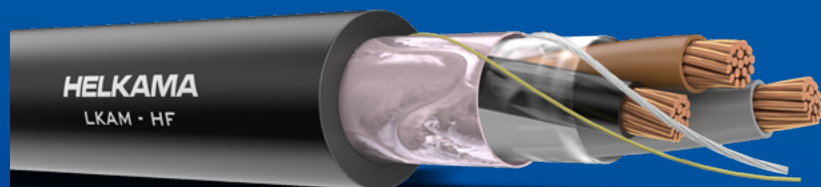

Photo credit: Meyer Turku

LKAM-HF

0.6/1 kV

Screened power and control cable



- Flame-retardant • Halogen-free • Low smoke emission • Oil resistant (SHF2 only)

CONDUCTOR	Stranded copper conductor 1.5-2.5 mm ² , IEC 60228 Class 2
INSULATION	XLPE
CABLING	Cabling, cores twisted together, covered by separator tape
SCREEN	Drain wire tinned copper Aluminium polyester tape, coverage 100%
SHEATH	Polyolefine SHF1, IEC 60092-360 Thermosetting polyolefine SHF2 on request Standard colour black, other colours on request
REFERENCE STANDARD	IEC 60092-353

APPLICATION

Screened power and control cable. For fixed installation in most areas, and on open deck in ships and offshore units, especially when lightweight screened cables are needed.

PHYSICAL PROPERTIES:

CORE IDENTIFICATION	Colour code for 1...4 core cables, number code for 5...37 core cables
MARINE TYPE APPROVALS	ABS, BV, CCS, CRS, DNV, KR, LR, RINA

MAIN CHARACTERISTICS:

RATED VOLTAGE	AC 0.6/1 kV (1.2 kV) DC 0.9/1.5 kV (if voltage to earth does not exceed 0.9 kV)
FIRE PERFORMANCE	IEC 60332-1-2 IEC 60332-3-22
HALOGEN-FREE	IEC 60754 series
SMOKE EMISSION	IEC 61034 series
OIL RESISTANCE (SHF2 only)	IEC 60811-404 conditions according to 60092-360/SHF2
MIN. INSTALLATION TEMPERATURE	-15 °C
OPERATING TEMPERATURE	-40 - 80 °C fixed installation
MAXIMUM CONDUCTOR TEMPERATURE	90 °C

Subject to change without prior notice. See latest update on our webpage.

© 2022 Helkama Bica Oy. All rights reserved.

LKAM-HF 0.6/1 kV

Part number	G-type	No. of conductors x Conductor area (mm ²)	Nominal outer Ø (mm)	Weight kg/km	Current rating A	Min. bending radius mm (fixed)
27102	-	2 x 1.5	9.0	100	20	55
27106	27107	3 x 1.5	9.5	125	16	55
27110	27111	4 x 1.5	10.0	145	16	60
27114	27115	5 x 1.5	11.0	175	13	65
27118	27119	7 x 1.5	12.0	220	12	70
27140	27141	10 x 1.5	15.5	310	11	90
27122	27123	12 x 1.5	16.0	350	10	95
27144	27145	14 x 1.5	16.5	395	10	100
27148	27149	16 x 1.5	17.5	450	9	105
27126	27127	19 x 1.5	18.5	510	9	110
27130	27131	24 x 1.5	22.0	650	8	130
27134	27135	27 x 1.5	22.5	715	8	135
27155	27156	32 x 1.5	23.5	825	7	140
27136	27137	37 x 1.5	25.0	935	7	150
27104	-	2 x 2.5	9.5	125	26	60
27108	27109	3 x 2.5	10.5	160	21	60
27112	27113	4 x 2.5	11.0	195	21	65
27116	27117	5 x 2.5	12.5	240	17	75
27120	27121	7 x 2.5	13.5	300	16	80
27142	27143	10 x 2.5	17.5	435	14	105
27124	27125	12 x 2.5	18.0	495	13	105
27146	27147	14 x 2.5	18.5	560	13	110
27150	27151	16 x 2.5	19.5	630	12	120
27128	27129	19 x 2.5	21.0	740	11	125
27132	27133	24 x 2.5	25.0	935	10	150
27138	27139	27 x 2.5	25.5	1025	10	150
27157	27158	32 x 2.5	26.5	1195	9	160
27152	27153	37 x 2.5	28.5	1355	9	170

Standard length 1000 m

G-type with yellow/green earth conductor and G-marking on sheath e.g. 3G1.5

SHF2 on request. Part number for SHF2 cables 4 + code from above table → 4xxxxx

Other sizes on request.

LKMM-HF

0.6/1 kV

Unarmoured power cable with extruded filler

0.6/1 kV CABLES

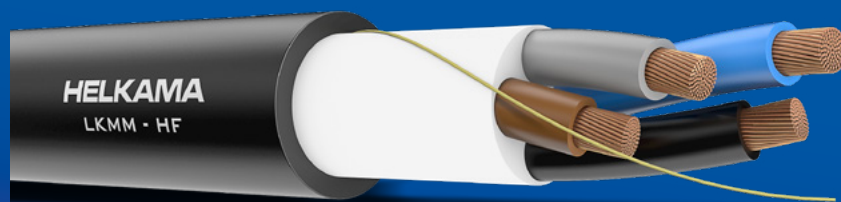

- Flame-retardant • Halogen-free • Low smoke emission • Oil resistant (SHF2 only)

CONDUCTOR	Stranded copper conductor 1.5-10 mm ² , IEC 60228 Class 2 Stranded copper conductor 16-240 mm ² , IEC 60228 Class 5
INSULATION	XLPE
CABLING/BEDDING	Cabling, cores twisted together. Bedding, extruded filler.
RIP CORD	For conductors ≥ 16 mm ²
SHEATH	Polyolefine SHF1, IEC 60092-360 Thermosetting polyolefine SHF2 on request Standard colour black, other colours on request
REFERENCE STANDARD	IEC 60092-353

APPLICATION

Unarmoured power cable with extruded filler. For fixed installation in most areas, and on open deck in ships and offshore units.

PHYSICAL PROPERTIES:

CORE IDENTIFICATION	Colour code for 1...4 core cables, number code for 5 core cables
MARINE TYPE APPROVALS	ABS, BV, CCS, CRS, DNV, KR, LR, RINA

MAIN CHARACTERISTICS:

RATED VOLTAGE	AC 0.6/1 kV (1.2 kV) DC 0.9/1.5 kV (if voltage to earth does not exceed 0.9 kV)
FIRE PERFORMANCE	IEC 60332-1-2 IEC 60332-3-22
HALOGEN-FREE	IEC 60754 series
SMOKE EMISSION	IEC 61034 series
OIL RESISTANCE (SHF2 only)	IEC 60811-404 conditions according to 60092-360/SHF2
MIN. INSTALLATION TEMPERATURE	-15 °C
OPERATING TEMPERATURE	-40 - 80 °C fixed installation
MAXIMUM CONDUCTOR TEMPERATURE	90 °C

Subject to change without prior notice. See latest update on our webpage.

© 2022 Helkama Bica Oy. All rights reserved.

LKMM-HF 0.6/1 kV

Part number	G-type	No. of conductors x Conductor area (mm ²)	Nominal outer Ø (mm)	Weight kg/km	Current rating A	Min. bending radius mm (fixed)
27532	-	2 x 1.5	9.0	125	20	35
27534	-	2 x 2.5	10.0	170	26	40
27536	-	2 x 4	11.0	225	34	45
27538	-	2 x 6	12.5	295	44	50
27540	-	2 x 10	14.5	440	61	60
27543	-	2 x 16 cl5	19.0	635	80	75
27545	-	2 x 25 cl5	23.5	955	105	95
27547	-	2 x 35 cl5	25.0	1290	130	150
27549	-	2 x 50 cl5	29.0	1755	167	175
27551	-	2 x 70 cl5	33.5	2400	204	200
27564	27566	3 x 1.5	9.5	140	16	35
27568	27570	3 x 2.5	10.5	190	21	45
27572	27574	3 x 4	12.0	260	28	45
27576	27578	3 x 6	13.5	360	36	55
27580	27582	3 x 10	15.5	530	50	60
27585	27587	3 x 16 cl5	20.0	765	66	80
27589	27591	3 x 25 cl5	24.5	1160	86	100
27593	27595	3 x 35 cl5	26.5	1555	107	160
27597	27599	3 x 50 cl5	30.5	2130	137	185
27601	27603	3 x 70 cl5	36.0	2985	168	215
27605	27607	3 x 95 cl5	39.5	3795	199	240
27609	27611	3 x 120 cl5	44.5	4775	232	265
27613	27615	3 x 150 cl5	51.0	6075	267	305
27617	27619	3 x 185 cl5	56.0	7405	300	335
27621	27623	3 x 240 cl5	63.0	9795	355	380
27628	27630	4 x 1.5	10.5	175	16	40
27632	27634	4 x 2.5	11.5	225	21	45
27636	27638	4 x 4	13.0	320	28	50
27640	27642	4 x 6	14.5	430	36	60
27644	27646	4 x 10	17.5	650	50	70
27649	27651	4 x 16 cl5	22.5	950	66	90
27653	27655	4 x 25 cl5	27.0	1425	86	165
27657	27659	4 x 35 cl5	29.5	1910	107	175
27661	27663	4 x 50 cl5	34.5	2655	137	205
27665	27667	4 x 70 cl5	40.0	3680	168	240
27692	27694	5 x 1.5	11.5	205	13	45
27696	27698	5 x 2.5	12.5	270	17	50
27700	27702	5 x 4	14.5	360	23	55
27704	27706	5 x 6	16.5	515	30	65
27708	27710	5 x 10	19.0	770	42	75
27713	27715	5 x 16 cl5	24.0	1160	55	95
27717	27719	5 x 25 cl5	30.0	1760	71	180

Standard length 1000 m

G-type with yellow/green earth conductor and G-marking on sheath e.g. 3G1.5

SHF2 on request. Part number for SHF2 cables 4 + code from above table → 4xxxxx

Other sizes on request.

LKMSM-HF

0.6/1 kV

Armoured power cable with extruded filler

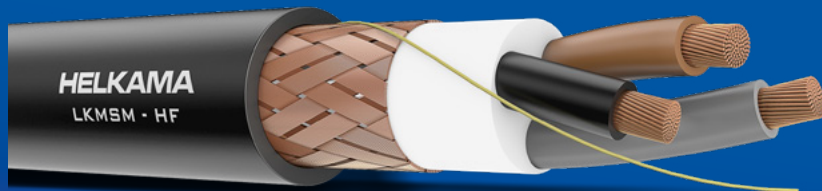

- Flame-retardant • Halogen-free • Low smoke emission • Oil resistant (SHF2 only)

CONDUCTOR	Stranded copper conductor 1.5-10 mm ² , IEC 60228 Class 2 Stranded copper conductor 16-150 mm ² , IEC 60228 Class 5
INSULATION	XLPE
CABLING/BEDDING	Cabling, cores twisted together. Bedding, extruded filler.
ARMOUR	Copper wire braid, coverage > 90%, IEC 60092-350 Tinned copper wire braid on request
RIP CORD	For conductors ≥ 16 mm ²
SHEATH	Polyolefine SHF1, IEC 60092-360 Thermosetting polyolefine SHF2 on request Standard colour black, other colours on request
REFERENCE STANDARD	IEC 60092-353

APPLICATION

Armoured power cable with extruded filler. For fixed installation in most areas, and on open deck in ships and offshore units.

PHYSICAL PROPERTIES:

CORE IDENTIFICATION	Colour code for 1...4 core cables, number code for 5 core cables
MARINE TYPE APPROVALS	ABS, BV, CCS, CRS, DNV, KR, LR, RINA

MAIN CHARACTERISTICS:

RATED VOLTAGE	AC 0.6/1 kV (1.2 kV) DC 0.9/1.5 kV (if voltage to earth does not exceed 0.9 kV)
FIRE PERFORMANCE	IEC 60332-1-2 IEC 60332-3-22
HALOGEN-FREE	IEC 60754 series
SMOKE EMISSION	IEC 61034 series
OIL RESISTANCE (SHF2 only)	IEC 60811-404 conditions according to 60092-360/SHF2
MIN. INSTALLATION TEMPERATURE	-15 °C
OPERATING TEMPERATURE	-40 - 80 °C fixed installation
MAXIMUM CONDUCTOR TEMPERATURE	90 °C

Subject to change without prior notice. See latest update on our webpage.

© 2022 Helkama Bica Oy. All rights reserved.

LKMSM-HF 0.6/1 kV

Part number	G-type	No. of conductors x Conductor area (mm ²)	Cross-section of armour mm ²	Nominal outer Ø (mm)	Weight kg/km	Current rating A	Min. bending radius mm (fixed)
27232	-	2 x 1.5	4.9	11.5	190	20	70
27234	-	2 x 2.5	5.4	12.5	225	26	75
27236	-	2 x 4	6.0	14.0	285	34	85
27238	-	2 x 6	9.2	15.5	415	44	90
27240	-	2 x 10	10.7	17.5	565	61	105
27243	-	2 x 16 cl5	12.6	20.5	735	80	120
27245	-	2 x 25 cl5	15.6	24.5	1070	105	150
27247	-	2 x 35 cl5	16.8	26.5	1350	130	160
27249	-	2 x 50 cl5	19.6	30.0	1800	167	180
27264	27266	3 x 1.5	5.3	12.0	220	16	75
27268	27270	3 x 2.5	5.7	13.5	270	21	80
27272	27274	3 x 4	8.7	15.0	360	28	90
27276	27278	3 x 6	9.7	16.0	485	36	95
27280	27282	3 x 10	11.5	18.5	675	50	110
27285	27287	3 x 16 cl5	13.4	22.0	905	66	130
27289	27291	3 x 25 cl5	16.7	26.0	1310	86	155
27293	27295	3 x 35 cl5	18.4	28.0	1665	107	170
27297	27299	3 x 50 cl5	21.0	32.5	2250	137	195
27301	27303	3 x 70 cl5	24.7	37.5	3095	168	225
27305	27307	3 x 95 cl5	38.8	42.0	4020	199	250
27309	27311	3 x 120 cl5	41.9	46.5	4990	232	280
27313	27315	3 x 150 cl5	50.2	53.0	6275	267	320
27328	27330	4 x 1.5	5.6	13.0	255	16	80
27332	27334	4 x 2.5	6.3	14.5	315	21	85
27336	27338	4 x 4	9.5	16.0	425	28	95
27340	27342	4 x 6	10.6	17.5	580	36	105
27344	27346	4 x 10	12.6	20.0	815	50	120
27349	27351	4 x 16 cl5	14.8	23.5	1085	66	140
27353	27355	4 x 25 cl5	18.5	28.5	1595	86	170
27357	27359	4 x 35 cl5	19.9	31.0	2055	107	185
27361	27363	4 x 50 cl5	23.2	35.5	2775	137	215
27365	27367	4 x 70 cl5	37.8	42.0	3945	168	250
27369	27371	4 x 95 cl5	41.7	46.5	5010	199	280
27373	27375	4 x 120 cl5	46.9	51.5	6240	232	310
27392	27394	5 x 1.5	6.1	14.0	295	13	85
27396	27398	5 x 2.5	9.3	15.5	390	17	95
27400	27402	5 x 4	10.4	17.0	505	23	105
27404	27406	5 x 6	11.6	19.0	680	30	115
27408	27410	5 x 10	13.8	22.0	975	42	130
27413	27415	5 x 16 cl5	16.3	25.5	1320	55	155
27417	27419	5 x 25 cl5	20.3	31.0	1930	71	185

Standard length 1000 m

G-type with yellow/green earth conductor and G-marking on sheath e.g. 3G1.5

SHF2 on request. Part number for SHF2 cables 4 + code from above table → 4xxxxx

Other sizes on request.

LKEM-HF

0.6/1 kV
Switchboard wire

0.6/1 kV CABLES

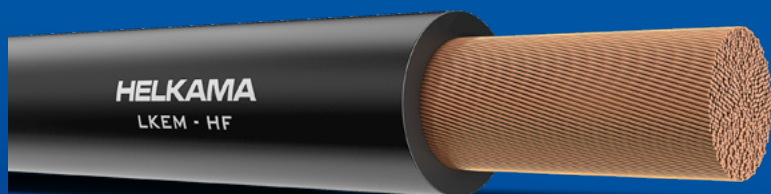

- Flame-retardant • Halogen-free • Low smoke emission • Oil resistant (SHF2 only)

CONDUCTOR	Stranded flexible copper conductor, IEC 60228 Class 5
INSULATION	HF90, IEC 60092-360 Thermosetting polyolefine SHF2 starting from 10 mm ² on request Standard colour black, other colours on request
REFERENCE STANDARD	IEC 60092-353

APPLICATION

Switchboard wire. For fixed wiring in switchboards, control panels and other enclosures.

PHYSICAL PROPERTIES:

MARINE TYPE APPROVALS	ABS, BV, CRS, DNV, KR, LR, RINA
------------------------------	---------------------------------

MAIN CHARACTERISTICS:

RATED VOLTAGE	AC 0.6/1 kV (1.2 kV) DC 0.9/1.5 kV (if voltage to earth does not exceed 0.9 kV)
FIRE PERFORMANCE	IEC 60332-1-2 IEC 60332-3-22
HALOGEN-FREE	IEC 60754 series
SMOKE EMISSION	IEC 61034 series
OIL RESISTANCE (SHF2 only)	IEC 60811-404 conditions according to 60092-360/SHF2
MIN. INSTALLATION TEMPERATURE	-15 °C
OPERATING TEMPERATURE	-40 – 80 °C fixed installation
MAXIMUM CONDUCTOR TEMPERATURE	90 °C

Subject to change without prior notice. See latest update on our webpage.

© 2022 Helkama Bica Oy. All rights reserved.

LKEM-HF 0.6/1 kV

Part number	No. of conductors x Conductor area (mm ²)	Nominal outer Ø (mm)	Weight kg/km	Current rating A	Min. bending radius mm (fixed)
25117*	1 x 0.5	2.3	10	11	10
25120	1 x 0.75	2.7	14	14	15
25121	1 x 1.0	2.8	17	17	15
25122	1 x 1.5	3.1	21	22	15
25124	1 x 2.5	3.6	32	30	15
25125	1 x 4	4.1	45	39	20
25126	1 x 6	4.7	63	50	20
25128	1 x 10	5.7	103	71	25
25130	1 x 16	6.7	153	94	30
25132	1 x 25	8.6	241	123	35
25134	1 x 35	9.4	329	153	40
25136	1 x 50	11.3	467	196	50
25138	1 x 70	13.2	661	240	55
25165	1 x 95	14.8	868	284	60
25166	1 x 120	16.8	1103	331	70
25279	1 x 150	19.4	1396	381	80
25281	1 x 185	21.3	1711	429	90
25283	1 x 240	24.4	2303	507	100
25285	1 x 300	27.4	2853	582	110

* Rated voltage 300/500 V

Other sizes on request

Standard lengths:

0.5 mm² - 2.5 mm² in 200 m box or 500 m drum

4 mm² - 6 mm² in 100 m box/coil or 500 m drum

≥ 10 mm² lengths per request

Available colours in stock: black, red, yellow/green

Available colours on request: blue, dark blue, brown, grey, yellow, green, orange, violet, white, or contact customer.care@helkamabica.fi for custom colours

LKM-FRHF

0.6/1 kV

Fire-resistant unarmoured power and control cable

0.6/1 kV CABLES

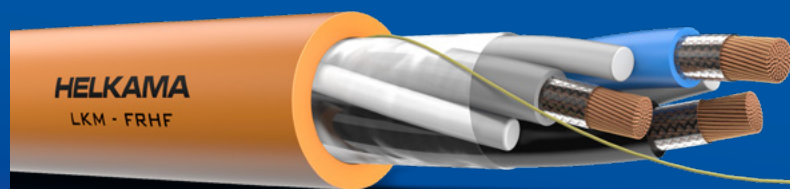

- Flame-retardant • Halogen-free • Low smoke emission • Oil resistant (SHF2 only)

CONDUCTOR	Stranded copper conductor 1.0-10 mm ² , IEC 60228 Class 2 Stranded copper conductor 16-300 mm ² , IEC 60228 Class 5
INSULATION	Mica tape XLPE
CABLING	Cores twisted together, with optional fillers or dummy cores to obtain symmetrical and round construction, covered by separator tape
RIP CORD	For conductors ≥ 16 mm ²
SHEATH	Polyolefine SHF1, IEC 60092-360 Thermosetting polyolefine SHF2 on request Standard colour orange, SHF2 standard colour black, other colours on request
REFERENCE STANDARD	IEC 60092-353

APPLICATION

Fire-resistant unarmoured power and control cable. For fixed installation in most areas, and on open deck in ships and offshore units. If the cable is exposed to direct sunlight, protective covering or cable with black outer sheath is recommended.

PHYSICAL PROPERTIES:

CORE IDENTIFICATION	Colour code for 1...4 core cables, number code for 5...37 core cables
MARINE TYPE APPROVALS	ABS, BV, CCS, CRS, DNV, KR, LR, RINA

MAIN CHARACTERISTICS:

RATED VOLTAGE	AC 0.6/1 kV (1.2 kV) DC 0.9/1.5 kV (if voltage to earth does not exceed 0.9 kV)
FIRE PERFORMANCE	IEC 60332-1-2 IEC 60332-3-22
FIRE-RESISTANT	IEC 60331-1 / IEC 60331-2 (180 min)
HALOGEN-FREE	IEC 60754 series
SMOKE EMISSION	IEC 61034 series
OIL RESISTANCE (SHF2 only)	IEC 60811-404 conditions according to 60092-360/SHF2
MIN. INSTALLATION TEMPERATURE	-15 °C
OPERATING TEMPERATURE	-40 - 80 °C fixed installation
MAXIMUM CONDUCTOR TEMPERATURE	90 °C

Subject to change without prior notice. See latest update on our webpage.

© 2022 Helkama Bica Oy. All rights reserved.

LKM-FRHF 0.6/1 kV

Part number	G-type	No. of conductors x Conductor area (mm ²)	Nominal outer Ø (mm)	Weight kg/km	Current rating A	Min. bending radius mm (fixed)
28275	-	1 x 1.0	5.5	40	18	30
28100	-	1 x 1.5	5.5	45	23	35
28102	-	1 x 2.5	6.0	60	30	35
28104	-	1 x 4	6.5	80	40	40
28106	-	1 x 6	7.5	105	52	45
28108	-	1 x 10	8.5	150	72	50
29326	-	1 x 16 cl5	9.5	200	94	40
29327	-	1 x 25 cl5	11.5	305	123	50
29328	-	1 x 35 cl5	12.5	400	153	55
29329	-	1 x 50 cl5	14.5	555	196	60
29330	-	1 x 70 cl5	16.5	765	240	70
29331	-	1 x 95 cl5	18.5	985	284	75
29332	-	1 x 120 cl5	20.5	1235	331	85
29333	-	1 x 150 cl5	23.5	1555	381	95
29334	-	1 x 185 cl5	25.5	1880	429	155
29335	-	1 x 240 cl5	28.5	2495	507	175
29336	-	1 x 300 cl5	32.0	3075	582	195
28276	-	2 x 1.0	8.5	75	15	50
28132	-	2 x 1.5	9.0	90	20	55
28134	-	2 x 2.5	10.5	125	26	60
28136	-	2 x 4	11.5	170	34	70
28138	-	2 x 6	12.5	260	44	75
28140	-	2 x 10	15.0	385	61	90
29343	-	2 x 16 cl5	17.5	545	80	70
29344	-	2 x 25 cl5	21.5	825	105	90
29345	-	2 x 35 cl5	23.5	1090	130	95
29346	-	2 x 50 cl5	27.5	1495	167	165
29347	-	2 x 70 cl5	31.5	2050	204	190
29348	-	2 x 95 cl5	35.5	2705	241	215
28278	28279	3 x 1.0	8.5	90	13	50
28162	28163	3 x 1.5	9.5	115	16	60
28164	28165	3 x 2.5	11.0	160	21	65
28166	28167	3 x 4	12.0	220	28	75
28168	28169	3 x 6	13.5	330	36	80
28170	28171	3 x 10	16.0	490	50	95
29366	29367	3 x 16 cl5	18.5	690	66	75
29368	29369	3 x 25 cl5	23.0	1060	86	95
29370	29371	3 x 35 cl5	25.0	1380	107	155
29372	29373	3 x 50 cl5	29.5	1930	137	180
29374	29375	3 x 70 cl5	34.0	2695	168	205
29376	29377	3 x 95 cl5	38.0	3475	199	230
29378	29379	3 x 120 cl5	42.5	4405	232	255
29380	29381	3 x 150 cl5	48.5	5525	267	290
29382	29383	3 x 185 cl5	53.5	6775	300	325
29384	29385	3 x 240 cl5	60.5	8935	355	365
28280	28281	4 x 1.0	9.5	115	13	55
28182	28183	4 x 1.5	11.0	150	16	65
28184	28185	4 x 2.5	12.0	200	21	70

Standard length 1000 m

G-type with yellow/green earth conductor and G-marking on sheath e.g. 3G1.5
SHF2 on request. Part number for SHF2 cables 4 + code from above table → 4xxxxx

Table continues on next page

LKM-FRHF 0.6/1 kV

Part number	G-type	No. of conductors x Conductor area (mm ²)	Nominal outer Ø (mm)	Weight kg/km	Current rating A	Min. bending radius mm (fixed)
28186	28187	4 x 4	13.5	280	28	80
28188	28189	4 x 6	15.0	410	36	90
28190	28191	4 x 10	17.5	620	50	105
29400	29401	4 x 16 cl5	20.5	870	66	85
29402	29403	4 x 25 cl5	25.5	1345	86	155
29404	29405	4 x 35 cl5	28.0	1770	107	170
29406	29407	4 x 50 cl5	33.0	2485	137	200
29408	29409	4 x 70 cl5	38.0	3425	168	230
29410	29411	4 x 95 cl5	42.5	4455	199	255
28282	28283	5 x 1.0	11.0	150	10	65
28212	28213	5 x 1.5	12.0	190	13	70
28214	28215	5 x 2.5	13.0	250	17	80
28501	28502	5 x 4	15.0	350	23	90
28503	28504	5 x 6	16.5	520	30	100
28505	28506	5 x 10	19.5	765	42	115
29434	29435	5 x 16 cl5	22.5	1065	55	95
29436	29437	5 x 25 cl5	28.5	1670	71	175
29438	29439	5 x 35 cl5	31.0	2210	89	185
29440	29441	5 x 50 cl5	36.5	3080	114	220
29442	29443	5 x 70 cl5	42.5	4305	139	255
28284	28285	7 x 1.0	11.5	180	9	70
28286	28287	10 x 1.0	15.0	265	8	90
28288	28289	12 x 1.0	15.5	290	8	90
28290	28291	14 x 1.0	16.0	330	7	95
28292	28293	16 x 1.0	17.0	380	7	105
28294	28295	19 x 1.0	18.0	430	7	110
28296	28297	24 x 1.0	21.5	545	6	130
28298	28299	27 x 1.0	22.0	600	6	130
28300	28301	37 x 1.0	24.5	800	5	150
28216	28217	7 x 1.5	13.0	230	12	75
28240	28241	10 x 1.5	16.5	330	11	100
28220	28221	12 x 1.5	17.5	380	10	105
28244	28245	14 x 1.5	18.0	430	10	110
28248	28249	16 x 1.5	19.0	485	9	115
28224	28225	19 x 1.5	20.5	565	9	120
28228	28229	24 x 1.5	24.0	725	8	145
28232	28233	27 x 1.5	24.5	795	8	150
28234	28235	37 x 1.5	28.0	1050	7	165
28218	28219	7 x 2.5	14.5	315	16	85
28242	28243	10 x 2.5	18.5	450	14	110
28222	28223	12 x 2.5	19.0	515	13	115
28246	28247	14 x 2.5	20.5	595	13	120
28250	28251	16 x 2.5	21.5	670	12	130
28226	28227	19 x 2.5	22.5	770	11	135
28230	28231	24 x 2.5	27.0	1000	10	160
28236	28237	27 x 2.5	27.5	1100	10	165
28238	28239	37 x 2.5	31.0	1460	9	185

Standard length 1000 m

G-type with yellow/green earth conductor and G-marking on sheath e.g. 3G1.5

SHF2 on request. Part number for SHF2 cables 4 + code from above table → 4xxxxx

Other sizes on request.

Subject to change without prior notice. See latest update on our webpage.

© 2022 Helkama Bica Oy. All rights reserved.



Photo credit: Arctech (Helsinki Shipyard since May 2019)

LKM-FRHF+WSR/WJR

0.6/1 kV

Fire-resistant + Water Spray Resistant and/or
Water Jet Resistant unarmoured power and control cable

0.6/1 kV CABLES

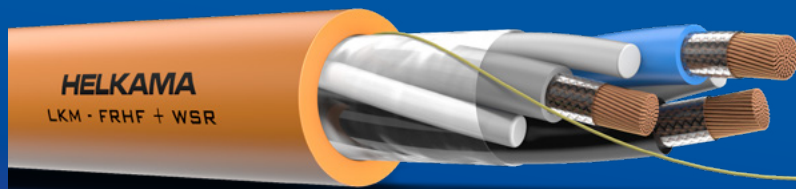

- Flame-retardant • Fire-resistant • Halogen-free • Low smoke emission • Water Spray and/or Water Jet Resistant

CONDUCTOR	Stranded copper conductor 1.0-10 mm ² , IEC 60228 Class 2 Stranded copper conductor 16-300 mm ² , IEC 60228 Class 5
INSULATION	Special grade Mica tape XLPE
CABLING	Cabling, cores twisted together, with optional fillers or dummy cores to obtain symmetrical and round construction, covered by separator tape
RIP CORD	For conductors ≥ 16 mm ²
SHEATH	Polyolefine SHF1, IEC 60092-360 Thermosetting polyolefine SHF2 on request Standard colour orange, SHF2 standard colour black, other colours on request
REFERENCE STANDARD	IEC 60092-353

APPLICATION

Fire-resistant + Water Spray Resistant and/or Water Jet Resistant unarmoured power and control cable. For fixed installation in most areas, and on open deck in ships and offshore units. Especially intended to ensure availability of all critical transportation-, comfort- and safety systems, i.e. to meet the concepts of; **Orderly Evacuation** (3 hours burning time) and **Safe Return to Port** (Fire test with simultaneous Water Spray / Water Jet + mechanical shocks) to simulate firefighting conditions.

If the cable is exposed to direct sunlight, protective covering or cable with black outer sheath is recommended.

PHYSICAL PROPERTIES:

CABLE TYPES	Cable $\varnothing \leq 20$ mm LKM-FRHF+WSR Cable $\varnothing > 20$ mm LKM-FRHF+WJR
CORE IDENTIFICATION	Colour code for 1...4 core cables, number code for 5...37 core cables
MARINE TYPE APPROVALS	DNV, LR, RINA

MAIN CHARACTERISTICS:

RATED VOLTAGE	AC 0.6/1 kV (1.2 kV) DC 0.9/1.5 kV (if voltage to earth does not exceed 0.9 kV)
FIRE PERFORMANCE	IEC 60332-1-2 IEC 60332-3-22
HALOGEN-FREE	IEC 60754 series
SMOKE EMISSION	IEC 61034 series
FIRE- AND WATER SPRAY RESISTANT (+WSR)	IEC 60331-2 + EN 50200 Annex E (180 min)
FIRE- AND WATER JET RESISTANT (+WJR)	IEC 60331-1 + BS 8491 (180 min)
OIL RESISTANCE (SHF2 only)	IEC 60811-404 conditions according to 60092-360/SHF2
MIN. INSTALLATION TEMPERATURE	-15 °C
OPERATING TEMPERATURE	-40 - 80 °C fixed installation
MAXIMUM CONDUCTOR TEMPERATURE	90 °C

LKM-FRHF+WSR/WJR 0.6/1 kV

Part number	G-type	No. of conductors x Conductor area (mm ²)	Nominal outer Ø (mm)	Weight kg/km	Current rating A	Min. bending radius mm (fixed)
628275	-	1 x 1.0	5.5	40	18	35
628100	-	1 x 1.5	6.0	50	23	35
628102	-	1 x 2.5	6.5	60	30	40
628104	-	1 x 4	7.0	80	40	40
628106	-	1 x 6	7.5	105	52	45
628108	-	1 x 10	8.5	155	72	50
629326	-	1 x 16 cl5	9.5	210	94	60
629327	-	1 x 25 cl5	12.0	320	123	70
629328	-	1 x 35 cl5	13.0	415	153	75
629329	-	1 x 50 cl5	15.0	570	196	90
629330	-	1 x 70 cl5	17.0	790	240	100
629331	-	1 x 95 cl5	18.5	1010	284	110
629332	-	1 x 120 cl5	20.5	1270	331	125
629333	-	1 x 150 cl5	23.5	1600	381	140
629334	-	1 x 185 cl5	26.0	1930	429	155
629335	-	1 x 240 cl5	29.0	2530	507	175
629336	-	1 x 300 cl5	32.0	3145	582	195
628276	-	2 x 1.0	8.5	105	15	50
628132	-	2 x 1.5	9.5	125	20	55
628134	-	2 x 2.5	11.0	160	26	65
628136	-	2 x 4	12.0	220	34	70
628138	-	2 x 6	13.0	320	44	80
628140	-	2 x 10	15.5	470	61	95
629343	-	2 x 16 cl5	18.0	625	80	105
629344	-	2 x 25 cl5	22.0	970	105	130
629345	-	2 x 35 cl5	24.0	1240	130	145
629346	-	2 x 50 cl5	27.5	1690	167	165
629347	-	2 x 70 cl5	32.0	2345	204	190
629348	-	2 x 95 cl5	35.5	3010	241	215
628278	628279	3 x 1.0	9.5	100	13	55
628162	628163	3 x 1.5	10.0	125	16	60
628164	628165	3 x 2.5	11.5	170	21	70
628166	628167	3 x 4	12.5	230	28	75
628168	628169	3 x 6	14.0	350	36	85
628170	628171	3 x 10	16.5	510	50	100
629366	629367	3 x 16 cl5	19.0	770	66	115
629368	629369	3 x 25 cl5	23.5	1170	86	140
629370	629371	3 x 35 cl5	25.5	1520	107	155
629372	629373	3 x 50 cl5	30.0	2115	137	180
629374	629375	3 x 70 cl5	34.5	2925	168	205
629376	629377	3 x 95 cl5	38.0	3755	199	230
629378	629379	3 x 120 cl5	43.0	4740	232	255
629380	629381	3 x 150 cl5	48.5	5950	267	290
629382	629383	3 x 185 cl5	54.0	7265	300	325
629384	629385	3 x 240 cl5	60.5	9565	355	365
628280	628281	4 x 1.0	10.0	125	13	60
628182	628183	4 x 1.5	11.5	165	16	70
628184	628185	4 x 2.5	12.5	210	21	75

Standard length 1000 m

G-type with yellow/green earth conductor and G-marking on sheath e.g. 3G1.5

SHF2 on request. Part number for SHF2 cables 4 + code from above table → 4xxxxx

Table continues on next page

LKM-FRHF+WSR/WJR 0.6/1 kV

Part number	G-type	No. of conductors x Conductor area (mm ²)	Nominal outer Ø (mm)	Weight kg/km	Current rating A	Min. bending radius mm (fixed)
628186	628187	4 x 4	14.0	295	28	85
628188	628189	4 x 6	15.5	430	36	95
628190	628191	4 x 10	18.5	640	50	110
629400	629401	4 x 16 cl5	21.0	940	66	125
629402	629403	4 x 25 cl5	26.0	1445	86	155
629404	629405	4 x 35 cl5	28.5	1880	107	170
629406	629407	4 x 50 cl5	33.5	2640	137	200
629408	629409	4 x 70 cl5	38.5	3645	168	230
629410	629411	4 x 95 cl5	43.0	4705	199	255
628282	628283	5 x 1.0	11.5	165	10	70
628212	628213	5 x 1.5	12.5	205	13	75
628214	628215	5 x 2.5	13.5	265	17	80
628501	628502	5 x 4	15.5	380	23	90
628503	628504	5 x 6	17.0	545	30	105
628505	628506	5 x 10	20.0	805	42	120
629434	629435	5 x 16 cl5	23.0	1120	55	140
629436	629437	5 x 25 cl5	29.0	1740	71	175
629438	629439	5 x 35 cl5	31.5	2270	89	190
629440	629441	5 x 50 cl5	37.0	3190	114	220
629442	629443	5 x 70 cl5	43.0	4455	139	255
628284	628285	7 x 1.0	12.5	200	9	75
628286	628287	10 x 1.0	16.0	285	8	95
628288	628289	12 x 1.0	16.5	325	8	100
628290	628291	14 x 1.0	17.0	365	7	105
628292	628293	16 x 1.0	18.5	425	7	110
628294	628295	19 x 1.0	19.5	480	7	115
628296	628297	24 x 1.0	22.5	605	6	135
628298	628299	27 x 1.0	23.5	665	6	140
628563	-	30 x 1.0	24.0	725	6	145
628300	628301	37 x 1.0	26.5	890	5	160
628216	628217	7 x 1.5	13.5	250	12	80
628240	628241	10 x 1.5	17.5	365	11	105
628220	628221	12 x 1.5	18.5	410	10	110
628244	628245	14 x 1.5	19.0	465	10	115
628248	628249	16 x 1.5	20.0	535	9	120
628224	628225	19 x 1.5	21.5	610	9	130
628228	628229	24 x 1.5	25.5	785	8	155
628232	628233	27 x 1.5	26.0	860	8	155
-	-	30 x 1.5	27.0	940	7	165
628234	628235	37 x 1.5	29.5	1140	7	175
628218	628219	7 x 2.5	15.0	335	16	90
628242	628243	10 x 2.5	19.5	490	14	115
628222	628223	12 x 2.5	20.0	550	13	120
628246	628247	14 x 2.5	21.5	635	13	130
628250	628251	16 x 2.5	22.5	725	12	135
628226	628227	19 x 2.5	24.0	820	11	145
628230	628231	24 x 2.5	28.5	1070	10	170

Standard length 1000 m

G-type with yellow/green earth conductor and G-marking on sheath e.g. 3G1.5

SHF2 on request. Part number for SHF2 cables 4 + code from above table → 4xxxxx

Table continues on next page

LKM-FRHF+WSR/WJR 0.6/1 kV

Part number	G-type	No. of conductors x Conductor area (mm ²)	Nominal outer Ø (mm)	Weight kg/km	Current rating A	Min. bending radius mm (fixed)
628236	628237	27 x 2.5	29.0	1175	10	175
-	-	30 x 2.5	30.0	1290	10	180
628238	628239	37 x 2.5	33.0	1565	9	195

Standard length 1000 m

G-type with yellow/green earth conductor and G-marking on sheath e.g. 3G1.5

SHF2 on request. Part number for SHF2 cables 4 + code from above table → 4xxxxx

Other sizes on request.

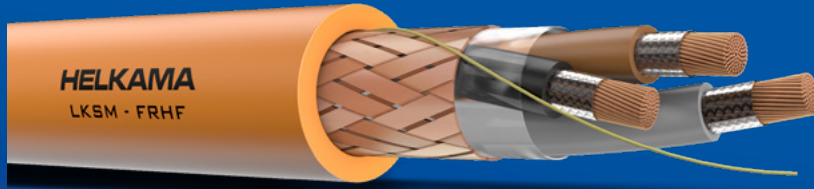

Photo credit: Meyer Turku

LKSM-FRHF

0.6/1 kV

Fire-resistant armoured power and control cable



- Flame-retardant • Fire-resistant • Halogen-free • Low smoke emission • Oil resistant (SHF2 only)

CONDUCTOR	Stranded copper conductor 1.0-10 mm ² , IEC 60228 Class 2 Stranded copper conductor 16-300 mm ² , IEC 60228 Class 5
INSULATION	Mica tape XLPE
CABLING/BEDDING	Cabling, cores twisted together, with optional fillers or dummy cores for symmetrical and round construction. Bedding, lapped tape.
ARMOUR	Copper wire braid, coverage > 90% Tinned copper wire braid on request
RIP CORD	For conductors ≥ 16 mm ²
SHEATH	Polyolefine SHF1, IEC 60092-360 Thermosetting polyolefine SHF2 on request Standard colour orange, SHF2 standard colour black, other colours on request
REFERENCE STANDARD	IEC 60092-353

APPLICATION

Fire-resistant armoured power and control cable. For fixed installation in most areas, and on open deck in ships and offshore units. If the cable is exposed to direct sunlight, protective covering or cable with black outer sheath is recommended.

PHYSICAL PROPERTIES:

CORE IDENTIFICATION Colour code for 1...4 core cables, number code for 5...37 core cables

MARINE TYPE APPROVALS ABS, BV, CCS, CRS, DNV, KR, LR, RINA

MAIN CHARACTERISTICS:

RATED VOLTAGE AC 0.6/1 kV (1.2 kV)
DC 0.9/1.5 kV (if voltage to earth does not exceed 0.9 kV)

FIRE PERFORMANCE IEC 60332-1-2
IEC 60332-3-22

FIRE-RESISTANT IEC 60331-1 / IEC 60331-2 (180 min)

HALOGEN-FREE IEC 60754 series

SMOKE EMISSION IEC 61034 series

OIL RESISTANCE (SHF2 only) IEC 60811-404 conditions according to 60092-360/SHF2

MIN. INSTALLATION TEMPERATURE -15 °C

OPERATING TEMPERATURE -40 - 80 °C fixed installation

MAXIMUM CONDUCTOR TEMPERATURE 90 °C

LKSM-FRHF 0.6/1 kV

Part number	G-type	No. of conductors x Conductor area (mm ²)	Cross-section of armour mm ²	Nominal outer Ø (mm)	Weight kg/km	Current rating A	Min. bending radius mm (fixed)
28541	-	1 x 1.0	3.0	6.5	75	18	40
28568	-	1 x 1.5	3.0	6.5	80	23	40
28570	-	1 x 2.5	3.1	7.0	95	30	45
28572	-	1 x 4	3.1	7.5	115	40	45
28574	-	1 x 6	3.1	8.5	140	52	50
28576	-	1 x 10	3.5	9.5	200	72	60
29060	27058	1 x 16 cl5	4.1	11.0	255	94	65
29061	27060	1 x 25 cl5	5.2	13.5	380	123	85
29062	27062	1 x 35 cl5	5.5	14.5	475	153	90
29063	27064	1 x 50 cl5	8.7	16.5	660	196	100
29064	27066	1 x 70 cl5	11.4	19.0	905	240	115
29065	27068	1 x 95 cl5	11.5	20.5	1125	284	125
29066	27070	1 x 120 cl5	12.3	22.5	1395	331	140
29067	27072	1 x 150 cl5	14.7	25.5	1735	381	155
29068	27074	1 x 185 cl5	15.2	27.5	2065	429	170
29069	27076	1 x 240 cl5	18.2	30.5	2710	507	185
29070	27078	1 x 300 cl5	18.7	34.0	3315	582	210
28542	-	2 x 1.0	3.5	9.5	120	15	60
28602	-	2 x 1.5	3.8	10.5	140	20	65
28604	-	2 x 2.5	4.3	11.5	170	26	70
28606	-	2 x 4	4.9	12.5	225	34	75
28608	-	2 x 6	5.4	14.0	345	44	85
28610	-	2 x 10	8.7	16.5	510	61	100
29071	-	2 x 16 cl5	10.0	19.0	665	80	115
29072	-	2 x 25 cl5	14.5	23.5	1030	105	145
29073	-	2 x 35 cl5	14.7	25.5	1290	130	155
29074	-	2 x 50 cl5	18.1	29.5	1735	167	180
29075	-	2 x 70 cl5	18.7	33.5	2320	204	205
29076	-	2 x 95 cl5	22.2	37.0	2985	241	225
28543	28544	3 x 1.0	4.1	10.0	145	13	60
28622	28623	3 x 1.5	4.1	11.0	170	16	65
28624	28625	3 x 2.5	4.6	12.0	210	21	70
28626	28627	3 x 4	5.2	13.5	280	28	80
28628	28629	3 x 6	5.8	14.5	400	36	90
28630	28631	3 x 10	9.3	17.5	605	50	105
29082	29083	3 x 16 cl5	10.7	20.0	815	66	120
29084	29085	3 x 25 cl5	14.6	25.0	1255	86	155
29086	29087	3 x 35 cl5	15.0	27.0	1575	107	165
29088	29089	3 x 50 cl5	17.5	31.5	2175	137	190
29090	29091	3 x 70 cl5	22.0	36.0	2970	168	220
29092	29093	3 x 95 cl5	22.8	40.0	3770	199	240
29094	29095	3 x 120 cl5	37.8	45.0	4860	232	270
29096	29097	3 x 150 cl5	39.3	51.0	6030	267	310
29098	29099	3 x 185 cl5	47.9	56.0	7370	300	340
29100	29101	3 x 240 cl5	50.7	63.0	9575	355	380
28545	28546	4 x 1.0	4.1	11.0	170	13	65
28642	28643	4 x 1.5	4.5	12.0	200	16	70
28644	28645	4 x 2.5	5.0	13.5	260	21	80

Standard length 1000 m

G-type with yellow/green earth conductor and G-marking on sheath e.g. 3G1.5

SHF2 on request. Part number for SHF2 cables 4 + code from above table → 4xxxxx

Table continues on next page

LKSM-FRHF 0.6/1 kV

Part number	G-type	No. of conductors x Conductor area (mm ²)	Cross-section of armour mm ²	Nominal outer Ø (mm)	Weight kg/km	Current rating A	Min. bending radius mm (fixed)
28646	28647	4 x 4	5.8	14.5	345	28	85
28648	28649	4 x 6	8.8	16.5	515	36	100
28650	28651	4 x 10	10.3	19.0	735	50	115
29104	29105	4 x 16 cl5	11.9	22.5	1005	66	135
29106	29107	4 x 25 cl5	14.8	27.5	1495	86	170
29108	29109	4 x 35 cl5	16.7	30.0	1935	107	180
29110	29111	4 x 50 cl5	19.5	35.0	2665	137	210
29112	29113	4 x 70 cl5	22.6	40.0	3615	168	240
29114	29115	4 x 95 cl5	35.0	45.0	4755	199	270
29116	29117	4 x 120 cl5	39.3	49.5	5930	232	300
29118	29119	4 x 150 cl5	48.2	56.5	7470	267	340
28547	28548	5 x 1.0	4.5	12.0	200	10	70
28662	28663	5 x 1.5	5.0	13.0	245	13	80
28664	28665	5 x 2.5	5.6	14.5	310	17	85
28705	28706	5 x 4	8.6	16.5	450	23	100
28707	28708	5 x 6	9.7	18.0	610	30	105
28709	28710	5 x 10	11.5	21.0	890	42	125
29126	29127	5 x 16 cl5	13.2	24.5	1205	55	150
29128	29129	5 x 25 cl5	18.1	30.5	1845	71	185
29130	29131	5 x 35 cl5	18.6	33.0	2395	89	200
29132	29133	5 x 50 cl5	22.4	38.5	3275	114	230
28549	28550	7 x 1.0	4.9	13.0	240	9	80
28551	28552	10 x 1.0	8.7	16.5	355	8	100
28553	28554	12 x 1.0	9.0	17.0	390	8	100
28555	28556	14 x 1.0	11.4	17.5	450	7	105
28557	28558	16 x 1.0	11.4	18.5	505	7	110
28559	28560	19 x 1.0	11.4	19.5	555	7	120
28561	28562	24 x 1.0	12.5	23.0	695	6	140
28563	28564	27 x 1.0	12.8	23.5	750	6	140
28565	28566	37 x 1.0	14.4	26.0	960	5	155
28666	28667	7 x 1.5	5.4	14.0	295	12	85
28723	28724	10 x 1.5	9.6	18.0	430	11	110
28670	28671	12 x 1.5	9.9	19.0	490	10	115
28727	28728	14 x 1.5	11.4	19.5	555	10	120
28731	28732	16 x 1.5	11.5	20.5	615	9	125
28674	28675	19 x 1.5	11.7	21.5	680	9	130
28678	28679	24 x 1.5	13.9	25.5	875	8	155
28682	28683	27 x 1.5	14.1	26.0	950	8	155
28684	28685	37 x 1.5	16.0	29.5	1225	7	175
28668	28669	7 x 2.5	8.5	16.0	410	16	95
28725	28726	10 x 2.5	11.5	20.0	570	14	120
28672	28673	12 x 2.6	11.5	20.5	640	13	125
28729	28730	14 x 2.5	11.8	22.0	735	13	130
28733	28734	16 x 2.5	12.5	23.0	825	12	140
28676	28677	19 x 2.5	13.2	24.5	925	11	145
28680	28681	24 x 2.5	15.7	28.5	1170	10	170
28686	28687	27 x 2.5	16.1	29.0	1275	10	175
28688	28689	37 x 2.5	18.1	33.0	1670	9	195

Standard length 1000 m

G-type with yellow/green earth conductor and G-marking on sheath e.g. 3G1.5

SHF2 on request. Part number for SHF2 cables 4 + code from above table → 4xxxxx

Other sizes on request.

Subject to change without prior notice. See latest update on our webpage.

© 2022 Helkama Bica Oy. All rights reserved.



Photo credit: Mercy Ships

LKSM-FRHF+WSR/WJR

0.6/1 kV

Fire-resistant + Water Spray Resistant and/or
Water Jet Resistant armoured power and control cable

0.6/1 kV CABLES

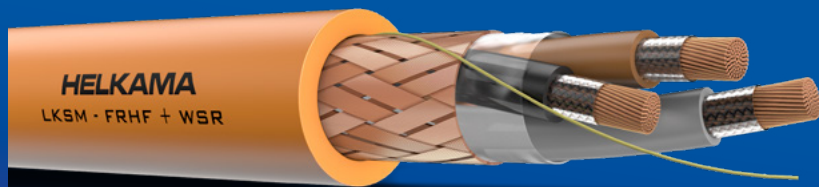

- Flame-retardant • Fire-resistant • Halogen-free • Low smoke emission • Water Spray and/or Water Jet Resistant

CONDUCTOR	Stranded copper conductor 1.0-10 mm ² , IEC 60228 Class 2 Stranded copper conductor 16-300 mm ² , IEC 60228 Class 5
INSULATION	Special grade Mica tape XLPE
CABLING/BEDDING	Cabling, cores twisted together, with optional fillers or dummy cores for symmetrical and round construction. Bedding, lapped tape.
ARMOUR	Copper wire braid, coverage > 90% Tinned copper wire braid on request
RIP CORD	For conductors ≥ 16 mm ²
SHEATH	Polyolefine SHF1, IEC 60092-360 Thermosetting polyolefine SHF2 on request Standard colour orange, SHF2 standard colour black, other colours on request
REFERENCE STANDARD	IEC 60092-353

APPLICATION

Fire-resistant + Water Spray Resistant and/or Water Jet Resistant armoured power and control cable. For fixed installation in most areas, and on open deck in ships and offshore units. Especially intended to ensure availability of all critical transportation-, comfort- and safety systems, i.e. to meet the concepts of; **Orderly Evacuation** (3 hours burning time) and **Safe Return to Port** (Fire test with simultaneous Water Spray / Water Jet + mechanical shocks) to simulate firefighting conditions.

If the cable is exposed to direct sunlight, protective covering or cable with black outer sheath is recommended.

PHYSICAL PROPERTIES:

CABLE TYPES	Cable Ø ≤20 mm LKSM-FRHF+WSR Cable Ø > 20 mm LKSM-FRHF+WJR
CORE IDENTIFICATION	Colour code for 1...4 core cables, number code for 5...37 core cables
MARINE TYPE APPROVALS	DNV, LR, RINA

MAIN CHARACTERISTICS:

RATED VOLTAGE	AC 0.6/1 kV (1.2 kV) DC 0.9/1.5 kV (if voltage to earth does not exceed 0.9 kV)
FIRE PERFORMANCE	IEC 60332-1-2 IEC 60332-3-22
HALOGEN-FREE	IEC 60754 series
SMOKE EMISSION	IEC 61034 series
FIRE- AND WATER SPRAY RESISTANT (+WSR)	IEC 60331-2 + EN 50200 Annex E (180 min)
FIRE- AND WATER JET RESISTANT (+WJR)	IEC 60331-1 + BS 8491 (180 min)
OIL RESISTANCE (SHF2 only)	IEC 60811-404 conditions according to 60092-360/SHF2
MIN. INSTALLATION TEMPERATURE	-15 °C
OPERATING TEMPERATURE	-40 - 80 °C fixed installation
MAXIMUM CONDUCTOR TEMPERATURE	90 °C

LKSM-FRHF+WSR/WJR 0.6/1 kV

Part number	G-type	No. of conductors x Conductor area (mm ²)	Cross-section of armour mm ²	Nominal outer Ø (mm)	Weight kg/km	Current rating A	Min. bending radius mm (fixed)
628541	-	1 x 1.0	3.0	6.5	75	18	40
628568	-	1 x 1.5	3.0	7.0	85	23	40
628570	-	1 x 2.5	3.1	7.5	95	30	45
628572	-	1 x 4	3.1	8.0	115	40	50
628574	-	1 x 6	3.1	8.5	145	52	50
628576	-	1 x 10	3.5	10.0	205	72	60
629060	627058	1 x 16 cl5	4.0	11.0	265	94	65
629061	627060	1 x 25 cl5	4.9	13.0	380	123	80
629062	627062	1 x 35 cl5	5.5	14.0	480	153	85
629063	627064	1 x 50 cl5	8.7	16.5	670	196	100
629064	627066	1 x 70 cl5	10.0	18.5	905	240	110
629065	627068	1 x 95 cl5	11.5	20.0	1140	284	120
629066	627070	1 x 120 cl5	12.3	22.5	1415	331	135
629067	627072	1 x 150 cl5	14.7	25.0	1760	381	150
629068	627074	1 x 185 cl5	15.2	27.5	2095	429	165
629069	627076	1 x 240 cl5	18.2	30.5	2725	507	180
629070	627078	1 x 300 cl5	18.7	34.0	3365	582	205
628542	-	2 x 1.0	3.5	10.0	155	15	60
628602	-	2 x 1.5	3.8	11.0	175	20	65
628604	-	2 x 2.5	4.3	12.0	205	26	70
628606	-	2 x 4	4.9	13.0	280	34	80
628608	-	2 x 6	5.4	14.5	405	44	85
628610	-	2 x 10	8.7	17.0	600	61	100
629071	-	2 x 16 cl5	10.0	19.5	770	80	115
629072	-	2 x 25 cl5	14.5	24.0	1215	105	145
629073	-	2 x 35 cl5	14.7	26.0	1460	130	155
629074	-	2 x 50 cl5	18.1	30.0	1950	167	180
629075	-	2 x 70 cl5	18.7	34.0	2645	204	205
629076	-	2 x 95 cl5	22.2	37.5	3315	241	225
628543	628544	3 x 1.0	4.1	10.5	155	13	65
628622	628623	3 x 1.5	4.1	11.5	180	16	70
628624	628625	3 x 2.5	4.6	12.5	220	21	75
628626	628627	3 x 4	5.2	14.0	295	28	85
628628	628629	3 x 6	5.8	15.0	420	36	90
628630	628631	3 x 10	9.3	18.0	625	50	110
629082	629083	3 x 16 cl5	10.7	20.5	905	66	125
629084	629085	3 x 25 cl5	14.6	25.5	1385	86	155
629086	629087	3 x 35 cl5	15.0	27.5	1710	107	165
629088	629089	3 x 50 cl5	18.3	32.0	2355	137	195
629090	629091	3 x 70 cl5	22.0	36.5	3190	168	220
629092	629093	3 x 95 cl5	22.8	40.5	4025	199	240
629094	629095	3 x 120 cl5	37.8	45.5	5170	232	270
629096	629097	3 x 150 cl5	39.3	51.5	6415	267	310
629098	629099	3 x 185 cl5	43.4	56.5	7770	300	340
629100	629101	3 x 240 cl5	49.1	63.5	10135	355	380
628545	628546	4 x 1.0	4.1	11.5	180	13	70
628642	628643	4 x 1.5	4.5	12.5	215	16	75
628644	628645	4 x 2.5	5.0	14.0	275	21	85

Standard length 1000 m

G-type with yellow/green earth conductor and G-marking on sheath e.g. 3G1.5 SHF2 on request. Part number for SHF2 cables 4 + code from above table → 4xxxxx

Table continues on next page

LKSM-FRHF+WSR/WJR 0.6/1 kV

Part number	G-type	No. of conductors x Conductor area (mm ²)	Cross-section of armour mm ²	Nominal outer Ø (mm)	Weight kg/km	Current rating A	Min. bending radiusmm (fixed)
628646	628647	4 x 4	5.8	15.0	360	28	90
628648	628649	4 x 6	8.8	17.0	535	36	100
628650	628651	4 x 10	10.3	20.0	760	50	120
629104	629105	4 x 16 cl5	11.9	23.0	1040	66	135
629106	629107	4 x 25 cl5	14.8	28.5	1550	86	170
629108	629109	4 x 35 cl5	18.1	30.5	1995	107	185
629110	629111	4 x 50 cl5	19.5	35.5	2715	137	210
629112	629113	4 x 70 cl5	22.4	40.5	3690	168	245
629114	629115	4 x 95 cl5	37.8	45.5	4860	199	270
629116	629117	4 x 120 cl5	39.3	50.5	6020	232	300
628547	628548	5 x 1.0	4.5	12.5	210	10	75
628662	628663	5 x 1.5	5.0	14.0	255	13	85
628664	628665	5 x 2.5	5.6	15.0	320	17	90
628705	628706	5 x 4	8.6	17.0	455	23	100
628707	628708	5 x 6	9.7	18.5	620	30	110
628709	628710	5 x 10	11.5	21.5	895	42	130
629126	629127	5 x 16 cl5	13.2	25.0	1230	55	150
629128	629129	5 x 25 cl5	18.1	31.0	1870	71	185
629130	629131	5 x 35 cl5	18.6	33.5	2415	89	200
629132	629133	5 x 50 cl5	21.6	39.0	3325	114	235
628549	628550	7 x 1.0	4.9	13.5	260	9	80
628551	628552	10 x 1.0	8.7	17.5	380	8	105
628553	628554	12 x 1.0	9.0	18.0	425	8	105
628555	628556	14 x 1.0	11.4	18.5	490	7	110
628557	628558	16 x 1.0	11.4	20.0	545	7	120
628559	628560	19 x 1.0	11.4	21.0	605	7	125
628561	628562	24 x 1.0	12.5	24.5	755	6	145
628563	628564	27 x 1.0	12.8	25.0	815	6	150
628564	-	30 x 1.0	13.3	26.0	885	5	155
628565	628566	37 x 1.0	14.4	28.0	1050	5	170
628666	628667	7 x 1.5	5.4	15.0	310	12	90
628723	628724	10 x 1.5	9.6	19.0	460	11	115
628670	628671	12 x 1.5	9.9	20.0	525	10	120
628727	628728	14 x 1.5	11.4	21.0	595	10	125
628731	628732	16 x 1.5	11.5	22.0	650	9	130
628674	628675	19 x 1.5	11.7	23.0	730	9	135
628678	628679	24 x 1.5	13.9	27.0	940	8	165
628682	628683	27 x 1.5	14.1	27.5	1015	8	165
-	-	30 x 1.5	14.7	28.5	1105	7	170
628684	628685	37 x 1.5	16.0	31.0	1315	7	185
628668	628669	7 x 2.5	8.5	16.5	430	16	100
628725	628726	10 x 2.5	11.5	21.0	600	14	125
628672	628673	12 x 2.5	11.5	21.5	675	13	130
628729	628730	14 x 2.5	11.8	23.0	780	13	140
628733	628734	16 x 2.5	12.5	24.5	865	12	145
628676	628677	19 x 2.5	13.2	25.5	980	11	155

Standard length 1000 m

G-type with yellow/green earth conductor and G-marking on sheath e.g. 3G1.5

SHF2 on request. Part number for SHF2 cables 4 + code from above table → 4xxxxx

Table continues on next page

LKSM-FRHF+WSR/WJR 0.6/1 kV

Part number	G-type	No. of conductors x Conductor area (mm ²)	Cross-section of armour mm ²	Nominal outer Ø (mm)	Weight kg/km	Current rating A	Min. bending radius mm (fixed)
628680	628681	24 x 2.5	15.7	30.0	1240	10	180
628686	628687	27 x 2.5	16.1	30.5	1350	10	185
-	-	30 x 2.5	16.7	32.0	1470	10	190
628688	628689	37 x 2.5	18.1	34.5	1775	9	205

Standard length 1000 m

G-type with yellow/green earth conductor and G-marking on sheath e.g. 3G1.5

SHF2 on request. Part number for SHF2 cables 4 + code from above table → 4xxxxx

Other sizes on request.



Photo credit/copyright: Helkama Bica Oy

LKSM-EMC-FRHF

0.6/1 kV

Fire-resistant armoured power and control cable with improved EMC-screening



- Flame-retardant • Fire-resistant • Halogen-free • Low smoke emission • Oil Resistant (SHF2 only)

CONDUCTOR	Stranded copper conductor 1.0-10 mm ² , IEC 60228 Class 2 Stranded copper conductor 16-300 mm ² , IEC 60228 Class 5
INSULATION	Special grade Mica tape XLPE
CABLING/BEDDING	Cabling, cores twisted together, with optional fillers or dummy cores for symmetrical and round construction. Bedding, lapped tape.
SCREEN	Copper tape, coverage 100%
ARMOUR	Copper wire braid, coverage > 90%, IEC 60092-350 Tinned copper wire braid on request
RIP CORD	For conductors ≥ 16 mm ²
SHEATH	Polyolefine SHF1, IEC 60092-360 Thermosetting polyolefine SHF2 on request Standard colour orange, SHF2 standard colour black, other colours on request
REFERENCE STANDARD	IEC 60092-353

APPLICATION

Fire-resistant armoured power and control cable with improved EMC-screening. For fixed installation in most areas, and on open deck in ships and offshore units. If the cable is exposed to direct sunlight, protective covering or cable with black outer sheath is recommended. Specially designed cables with screen for improved screening properties to address EMI/EMC problems.

PHYSICAL PROPERTIES:

CORE IDENTIFICATION	Colour code for 1...4 core cables, number code for 5...37 core cables
MARINE TYPE APPROVALS	ABS, BV, CCS, CRS, DNV, LR, RINA

MAIN CHARACTERISTICS:

RATED VOLTAGE	AC 0.6/1 kV (1.2 kV) DC 0.9/1.5 kV (if voltage to earth does not exceed 0.9 kV)
FIRE PERFORMANCE	IEC 60332-1-2 IEC 60332-3-22
FIRE-RESISTANT	IEC 60331-1 / IEC 60331-2 (180 min)
HALOGEN-FREE	IEC 60754 series
SMOKE EMISSION	IEC 61034 series
OIL RESISTANCE (SHF2 only)	IEC 60811-404 conditions according to 60092-360/SHF2
MIN. INSTALLATION TEMPERATURE	-15 °C
OPERATING TEMPERATURE	-40 - 80 °C fixed installation
MAXIMUM CONDUCTOR TEMPERATURE	90 °C

LKSM-EMC-FRHF 0.6/1 kV

Part number	G-type	No. of conductors x Conductor area (mm ²)	Cross-section of armour mm ²	Diameter of screen mm	Nominal outer Ø (mm)	Weight kg/km	Current rating A	Min. bending radiusmm (fixed)
-	-	1 x 1.0	3.0	4.5	6.5	90	18	40
-	-	1 x 1.5	3.0	4.5	7.0	100	23	40
-	-	1 x 2.5	3.1	5.0	7.5	110	30	45
-	-	1 x 4	3.1	5.5	8.0	130	40	45
-	-	1 x 6	3.1	6.0	8.5	155	52	50
-	-	1 x 10	3.5	7.0	10.0	215	72	60
-	-	1 x 16 cl5	4.1	8.5	11.0	285	94	65
-	-	1 x 25 cl5	4.8	10.5	13.0	410	123	80
-	-	1 x 35 cl5	5.5	11.5	14.0	515	153	85
-	-	1 x 50 cl5	8.6	13.5	17.0	705	196	100
-	-	1 x 70 cl5	10.0	15.5	18.5	935	240	110
-	-	1 x 95 cl5	11.5	18.0	21.5	1190	284	130
-	-	1 x 120 cl5	12.3	20.0	23.5	1465	331	140
-	-	1 x 150 cl5	14.7	22.5	26.5	1800	381	160
-	-	1 x 185 cl5	15.2	25.5	29.0	2165	429	175
-	-	1 x 240 cl5	16.9	28.5	32.5	2790	507	195
-	-	1 x 300 cl5	18.6	31.0	35.5	3420	582	210
-	-	2 x 1.0	3.7	7.5	10.0	140	15	60
27872	-	2 x 1.5	4.1	8.0	10.5	160	20	65
27873	-	2 x 2.5	4.5	9.0	11.5	190	26	70
27874	-	2 x 4	5.1	10.0	13.0	245	34	75
27875	-	2 x 6	5.6	11.0	14.0	365	44	85
27876	-	2 x 10	8.9	13.5	16.5	540	61	100
27877	-	2 x 16 cl5	11.4	15.5	19.0	730	80	115
27878	-	2 x 25 cl5	12.6	19.5	23.5	1070	105	140
27879	-	2 x 35 cl5	14.8	22.0	25.5	1350	130	155
27880	-	2 x 50 cl5	16.6	26.0	30.0	1815	167	180
27881	-	2 x 70 cl5	19.0	30.0	34.5	2420	204	205
-	-	2 x 95 cl5	21.5	35.0	39.5	3150	241	240
-	-	3 x 1.0	4.0	8.0	10.5	170	13	65
27882	28444	3 x 1.5	4.3	8.5	11.0	190	16	65
27883	28445	3 x 2.5	4.8	9.5	12.5	240	21	75
27884	28446	3 x 4	5.5	10.5	13.5	305	28	80
27885	28447	3 x 6	11.3	12.5	15.5	485	36	90
27886	28448	3 x 10	9.6	14.5	17.5	630	50	105
27887	28449	3 x 16 cl5	11.5	17.5	20.5	890	66	125
27888	28450	3 x 25 cl5	14.7	21.5	25.5	1315	86	155
27889	28451	3 x 35 cl5	15.8	24.0	28.0	1675	107	170
27890	28452	3 x 50 cl5	18.5	28.5	33.0	2280	137	200
27891	28453	3 x 70 cl5	22.2	32.5	37.5	3055	168	225
27892	28454	3 x 95 cl5	32.5	38.5	43.5	4055	199	260
27893	28455	3 x 120 cl5	36.1	42.5	48.0	4980	232	290
27894	28456	3 x 150 cl5	40.2	48.0	54.0	6200	267	325
-	-	4 x 1.0	4.4	9.0	11.5	195	13	70
27897	28459	4 x 1.5	4.8	9.5	12.5	230	16	75
27898	28460	4 x 2.5	5.4	10.5	13.5	280	21	80
27899	28461	4 x 4	11.3	12.0	15.0	420	28	90
27900	28462	4 x 6	9.2	13.5	16.5	540	36	100

Standard length 1000 m

G-type with yellow/green earth conductor and G-marking on sheath e.g. 3G1.5

SHF2 on request. Part number for SHF2 cables 4 + code from above table → 4xxxxx

Table continues on next page

LKSM-EMC-FRHF 0.6/1 kV

Part number	G-type	No. of conductors x Conductor area (mm ²)	Cross-section of armour mm ²	Diameter of screen mm	Nominal outer Ø (mm)	Weight kg/km	Current rating A	Min. bending radiusmm (fixed)
27905	28463	4 x 10	10.7	16.0	19.5	760	50	115
27906	28464	4 x 16 cl5	12.8	19.0	23.0	1095	66	135
27907	28465	4 x 25 cl5	15.6	24.0	28.0	1595	86	165
27908	28466	4 x 35 cl5	18.3	26.5	31.0	2090	107	185
27909	28467	4 x 50 Fcl5	20.4	32.0	36.5	2825	137	220
27910	28468	4 x 70 cl5	23.3	36.5	41.5	3840	168	250
27912	28469	4 x 95 cl5	36.1	43.0	48.5	5055	199	290
27913	28470	4 x 120 cl5	40.2	47.5	53.5	6285	232	320
-	-	4 x 150 cl5	44.8	53.5	60.5	7820	267	360
-	-	5 x 1.0	4.9	9.5	12.5	235	10	75
27914	28471	5 x 1.5	5.3	10.5	13.0	270	13	80
27915	28472	5 x 2.5	6.0	11.5	14.5	335	17	85
27916	28473	5 x 4	11.3	13.5	16.5	490	23	100
27917	28474	5 x 6	11.4	15.0	18.0	660	30	110
27918	28475	5 x 10	11.9	18.0	21.5	940	42	130
27919	28476	5 x 16 cl5	14.1	21.0	25.0	1325	55	150
27920	28477	5 x 25 cl5	17.2	26.5	30.5	1940	71	185
-	-	7 x 1.0	5.4	10.5	13.5	270	9	80
-	-	10 x 1.0	9.6	14.0	17.0	400	8	105
-	-	12 x 1.0	10.0	14.5	18.0	445	8	105
-	-	14 x 1.0	10.5	15.5	18.5	495	7	110
-	-	16 x 1.0	11.1	16.5	19.5	540	7	115
-	-	19 x 1.0	11.8	17.0	20.5	630	7	125
-	-	24 x 1.0	13.9	20.5	24.0	815	6	145
-	-	27 x 1.0	14.4	21.0	24.5	870	6	150
-	-	30 x 1.0	14.9	21.5	25.5	935	6	155
-	-	37 x 1.0	16.2	23.5	27.5	1090	5	165
27921	28478	7 x 1.5	5.9	11.5	14.5	315	12	85
27923	28480	10 x 1.5	10.5	15.0	18.5	475	11	110
27925	28482	12 x 1.5	10.9	15.5	19.0	525	10	115
27927	28484	14 x 1.5	11.5	16.5	20.0	585	10	120
27929	28486	16 x 1.5	12.2	17.5	21.0	665	9	125
27931	28488	19 x 1.5	12.9	18.5	22.0	780	9	135
27933	28490	24 x 1.5	15.3	22.0	26.0	975	8	155
27935	28492	27 x 1.5	15.8	22.5	26.5	1055	8	160
-	-	30 x 1.5	16.4	23.5	27.5	1135	7	165
27937	28494	37 x 1.5	17.8	25.5	30.0	1345	7	180
27922	28479	7 x 2.5	9.9	13.0	16.0	445	16	95
27924	28481	10 x 2.5	11.7	17.0	20.0	605	14	120
27926	28483	12 x 2.5	12.1	17.5	21.0	700	13	125
27928	28485	14 x 2.5	12.8	18.5	22.0	780	12	135
27930	28487	16 x 2.5	13.6	19.5	23.5	860	12	140
27932	28489	19 x 2.5	14.4	21.0	24.5	1020	11	150
27934	28491	24 x 2.5	17.2	24.5	28.5	1280	10	170
27936	28493	27 x 2.5	17.6	25.5	29.5	1410	10	180
-	-	30 x 2.5	18.3	26.5	30.5	1525	10	185
27938	28495	37 x 2.5	20.0	28.5	33.0	1790	9	200

Standard length 1000 m

G-type with yellow/green earth conductor and G-marking on sheath e.g. 3G1.5

SHF2 on request. Part number for SHF2 cables 4 + code from above table → 4xxxxx

Other sizes on request.

Subject to change without prior notice. See latest update on our webpage.

© 2022 Helkama Bica Oy. All rights reserved.

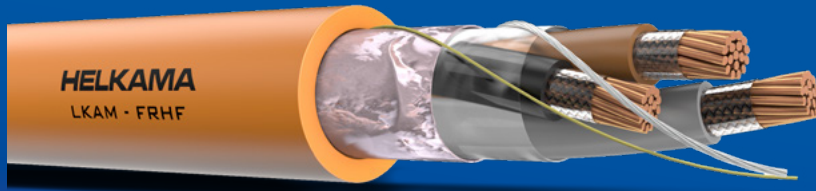

Photo credit: Sinikka Hälme via-Wikimedia commons

LKAM-FRHF

0.6/1 kV

Fire-resistant screened power and control cable



- Flame-retardant • Halogen-free • Low smoke emission • Oil resistant (SHF2 only)

CONDUCTOR	Stranded copper conductor 1.5-2.5 mm ² , IEC 60228 Class 2
INSULATION	Mica tape XLPE
CABLING	Cores twisted together, covered by separator tape
SCREEN	Drain wire tinned copper 1.0 mm ² Aluminium polyester tape, coverage 100%
SHEATH	Polyolefine SHF1, IEC 60092-360 Thermosetting polyolefine SHF2 on request Standard colour orange, SHF2 standard colour black, other colours on request
REFERENCE STANDARD	IEC 60092-353

APPLICATION

Fire-resistant screened power and control cable. For fixed installation in most areas, and on open deck in ships and off-shore units, especially when lightweight screened cables are needed. If the cable is exposed to direct sunlight, protective covering or cable with black outer sheath is recommended.

PHYSICAL PROPERTIES:

CORE IDENTIFICATION	Colour code for 1...4 core cables, number code for 5...37 core cables
MARINE TYPE APPROVALS	ABS, BV, CCS, CRS, DNV, KR, LR, RINA

MAIN CHARACTERISTICS:

RATED VOLTAGE	AC 0.6/1 kV (1.2 kV) DC 0.9/1.5 kV (if voltage to earth does not exceed 0.9 kV)
FIRE PERFORMANCE	IEC 60332-1-2 IEC 60332-3-22
FIRE-RESISTANT	IEC 60331-1 / IEC 60331-2 (180 min)
HALOGEN-FREE	IEC 60754 series
SMOKE EMISSION	IEC 61034 series
OIL RESISTANCE (SHF2 only)	IEC 60811-404 conditions according to 60092-360/SHF2
MIN. INSTALLATION TEMPERATURE	-15 °C
OPERATING TEMPERATURE	-40 - 80 °C fixed installation
MAXIMUM CONDUCTOR TEMPERATURE	90 °C

Subject to change without prior notice. See latest update on our webpage.

© 2022 Helkama Bica Oy. All rights reserved.

LKAM-FRHF 0.6/1 kV

Part number	G-type	No. of conductors x Conductor area (mm ²)	Nominal outer Ø (mm)	Weight kg/km	Current rating A	Min. bending radius mm (fixed)
28741	-	2 x 1.5	9.5	110	20	60
28743	28744	3 x 1.5	10.0	135	16	60
28747	28748	4 x 1.5	11.0	165	16	65
28751	28752	5 x 1.5	12.0	200	13	70
28755	28756	7 x 1.5	13.5	250	12	80
28759	28760	10 x 1.5	17.0	350	11	100
28763	28764	12 x 1.5	17.5	400	10	105
28767	28768	14 x 1.5	18.5	450	10	110
28771	28772	16 x 1.5	19.5	515	9	115
28775	28776	19 x 1.5	20.5	580	9	125
28779	28780	24 x 1.5	24.5	745	8	145
28783	28784	27 x 1.5	25.0	815	8	150
28787	28788	37 x 1.5	28.0	1070	7	170
28742	-	2 x 2.5	10.5	140	26	65
28745	28746	3 x 2.5	11.0	175	21	65
28749	28750	4 x 2.5	12.0	215	21	75
28753	28754	5 x 2.5	13.5	270	17	80
28757	28758	7 x 2.5	14.5	335	16	90
28761	28762	10 x 2.5	19.0	485	14	115
28765	28766	12 x 2.5	19.5	555	13	115
28769	28770	14 x 2.5	20.5	630	13	125
28773	28774	16 x 2.5	21.5	705	12	130
28777	28778	19 x 2.5	23.0	825	11	140
28781	28782	24 x 2.5	27.0	1045	10	165
28785	28786	27 x 2.5	28.0	1145	10	165
28789	28790	37 x 2.5	31.5	1515	9	190

Standard length 1000 m

G-type with yellow/green earth conductor and G-marking on sheath e.g. 3G1.5

SHF2 on request. Part number for SHF2 cables 4 + code from above table → 4xxxxx

Other sizes on request.



LKSM-VFD

1.8/3 kV

Armoured power and control cable
with improved EMC-screening

1.8/3 kV CABLES



• Flame-retardant • Halogen-free • Low smoke emission • Oil resistant (SHF2 only)

CONDUCTOR	Stranded copper conductor 16-300 mm ² , IEC 60228 Class 5
INSULATION	XLPE
CABLING/BEDDING	Cabling, cores twisted together, with optional fillers or dummy cores for symmetrical and round construction. Bedding, lapped tape.
SCREEN	Copper tape, coverage 100%
ARMOUR	Copper wire braid, coverage > 90%, IEC 60092-350
RIP CORD	For conductors ≥ 16 mm ²
SHEATH	Polyolefine SHF1, IEC 60092-360 Thermosetting polyolefine SHF2 on request Standard colour black, other colours on request
REFERENCE STANDARD	IEC 60092-353

APPLICATION

Armoured power and control cable. For fixed installation in most areas, and on open deck in ships and offshore units. Specially designed cables to meet requirements for Variable Frequency Drivers (VFD). Suitable for voltage peaks up to 3 kV.

PHYSICAL PROPERTIES:

CORE IDENTIFICATION	Colour code for 1...4 core cables, number code for 5...37 core cables
MARINE TYPE APPROVALS	ABS, BV, CCS, CRS, DNV, KR, LR, RINA

MAIN CHARACTERISTICS:

RATED VOLTAGE	1.8/3 kV (3.6 kV)
FIRE PERFORMANCE	IEC 60332-1-2 IEC 60332-3-22
HALOGEN-FREE	IEC 60754 series
SMOKE EMISSION	IEC 61034 series
OIL RESISTANCE (SHF2 only)	IEC 60811-404 conditions according to 60092-360/SHF2
TRANSFER IMPEDANCE	IEC 61196-1 (typical value 26 dB over 1 m Ω /m at 100 MHz [20 m Ω /m])
MIN. INSTALLATION TEMPERATURE	-15 °C
OPERATING TEMPERATURE	-40 - 80 °C fixed installation
MAXIMUM CONDUCTOR TEMPERATURE	90 °C

Subject to change without prior notice. See latest update on our webpage.

© 2022 Helkama Bica Oy. All rights reserved.

LKSM-VFD 1.8/3 kV

Part number	No. of conductors x Conductor area (mm ²)	Cross-section of armour mm ²	Nominal outer Ø (mm)	Weight kg/km	Current rating A	Min. bending radius mm (fixed)	Note
26918	1 x 10	4.6	13.0	270	72	105	x
26920	1 x 16	4.6	14.0	335	96	110	x
26922	1 x 25	10.1	16.0	480	127	130	x
26924	1 x 35	10.1	17.0	580	157	135	x
26926	1 x 50	10.2	18.5	740	196	150	x
26928	1 x 70	10.7	20.0	945	242	160	x
26930	1 x 95	11.9	22.0	1195	293	175	x
26932	1 x 120	13.1	24.0	1450	339	190	x
26934	1 x 150	13.9	26.0	1750	389	210	x
26936	1 x 185	16.0	27.5	2080	444	220	x
26938	1 x 240	16.5	30.5	2650	522	240	x
26940	1 x 300	18.0	33.5	3260	601	265	x
230211020	2 x 10 DC	11.6	20.5	680	61	165	1)
2302112020	2 x 16 DC	13.1	23.0	885	82	185	x
2302113020	2 x 25 DC	16.0	25.5	1180	108	205	1)
2302114020	2 x 35 DC	16.2	27.0	1410	133	220	x
2302115020	2 x 50 DC	18.0	30.5	1845	167	245	x
2302116020	2 x 70 DC	20.0	33.5	2415	206	270	x
2302117020	2 x 95 DC	35.6	37.5	3195	249	300	x
26892	3 x 10	13.0	23.5	845	50	185	1)
26871	3 x 16	14.3	26.5	1185	67	215	x
26873	3 x 25	16.2	30.0	1580	89	240	1)
26875	3 x 35	17.7	32.0	1940	110	255	1)
26877	3 x 50	34.4	35.5	2665	137	285	1)
26879	3 x 70	35.4	40.0	3545	169	320	1)
26881	3 x 95	36.6	43.5	4325	205	350	x
26883	3 x 120	38.1	47.5	5205	237	380	x
26885	3 x 150	41.2	52.5	6315	272	420	x
26887	3 x 185	44.5	55.5	7475	311	445	x
26889	3 x 240	49.5	62.0	9535	365	495	x
26891	3 x 300	53.7	68.5	11765	421	545	x
27165	3 x 10 + 3 x 4	13.1	24.0	970	50	195	2)
27166	3 x 16 + 3 x 6	14.3	26.5	1255	67	215	2)
27167	3 x 25 + 3 x 6	16.2	30.0	1605	89	240	2)
27168	3 x 35 + 3 x 6	17.7	32.0	1975	110	255	2)
27169	3 x 50 + 3 x 10	34.4	35.5	2755	137	285	2)
27170	3 x 70 + 3 x 16	35.4	39.0	3590	169	315	2)
26893	3 x 95 + 3 x 16	36.6	43.5	4430	205	350	2)
26895	3 x 120 + 3 x 25	38.1	47.5	5515	237	380	2)
26897	3 x 150 + 3 x 25	41.2	52.5	6520	272	420	2)
26899	3 x 185 + 3 x 35	44.5	55.5	7900	311	445	2)
26901	3 x 240 + 3 x 50	49.5	62.0	10345	365	495	2)
230211040	4 x 10 DC	13.9	26.0	1055	50	210	1)
2302112040	4 x 16 DC	16.2	29.5	1425	67	235	1)
2302113040	4 x 25 DC	17.8	33.0	1875	89	265	1)
2302114040	4 x 35 DC	19.7	35.0	2320	110	280	1)
2302115040	4 x 50 DC	25.2	40.0	3130	137	320	1)
2302116040	4 x 70 DC	36.7	44.0	4190	169	355	1)
2302117040	4 x 95 DC	38.9	48.5	5225	205	390	x
2302118040	4 x 120 DC	42.5	53.0	6435	237	425	x
2302119040	4 x 150 DC	45.9	58.0	7825	272	465	x
2302120040	4 x 185 DC	49.7	62.0	9290	311	495	x

NOTE!

PE-rules For cables ≤ 10mm² the PE-conductor must be same as main conductor.

For cables > 16mm² the PE-conductor must be half of main conductor and min. 16mm².

PE rule according to IEC 60092-352, Electrical installations in ships - (Choice and installation of electrical cables).

x = Protective earth (PE) rules are NOT fulfilled.

1) = Single Armour can be used as Protective Earth. PE-rules are fulfilled.

2) = Three additional protective earth (PE) conductors. Protective earth (PE) rules are fulfilled.

DC 2- and 4-core cables mainly used for DC voltage grids.

Colour of insulation for 2-core cables: Red/Black

Colour of insulation for 4-core cables: Red1 / Black1 / Red2 / Black2

Information given is indicative and doesn't involve any warranty on results. We reserve the right to change this datasheet.

Other sizes on request. SHF2 on request. Part number for SHF2 cables 4 + code from above table → 4xxxxx

LKM-HF

250 V

Unarmoured control and instrumentation cable

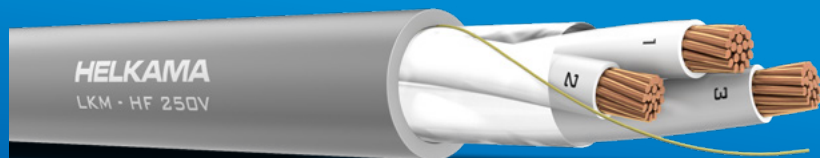

- Flame-retardant • Halogen-free • Low smoke emission • Oil resistant (SHF2 only)

CONDUCTOR	Stranded flexible copper conductor, IEC 60228 Class 5
INSULATION	XLPE
CABLING	Cores twisted together, covered by separator tape
SHEATH	Polyolefine SHF1, IEC 60092-360 Thermosetting polyolefine SHF2 on request Standard colour grey, other colours on request
REFERENCE STANDARD	IEC 60092-376

APPLICATION

Unarmoured control and instrumentation cable. For fixed installation in most areas, and on open deck in ships and offshore units. If the cable is exposed to direct sunlight, protective covering or cable with black outer sheath is recommended.

PHYSICAL PROPERTIES:

CORE IDENTIFICATION	Number code for core cables
MARINE TYPE APPROVALS	ABS, BV, CCS, CRS, DNV, KR, LR, RINA

MAIN CHARACTERISTICS:

RATED VOLTAGE	150/250 V (300 V)
FIRE PERFORMANCE	IEC 60332-1-2 IEC 60332-3-22
HALOGEN-FREE	IEC 60754 series
SMOKE EMISSION	IEC 61034 series
OIL RESISTANCE (SHF2 only)	IEC 60811-404 conditions according to 60092-360/SHF2
MIN. INSTALLATION TEMPERATURE	-15 °C
OPERATING TEMPERATURE	-40 - 80 °C fixed installation
MAXIMUM CONDUCTOR TEMPERATURE	90 °C

LKM-HF 250 V

Part number	No. of conductors x Conductor area (mm ²)	Nominal outer Ø (mm)	Weight kg/km	Current rating A	Min. bending radius mm (fixed)
27821	2 x 0.5	5.5	35	8.7	25
27822	3 x 0.5	6.0	45	7.6	25
27823	4 x 0.5	6.5	55	6.9	25
27824	5 x 0.5	7.5	65	6.4	30
27825	7 x 0.5	7.5	75	5.8	30
27826	10 x 0.5	9.5	115	5.1	40
27827	12 x 0.5	10.0	125	4.8	40
27828	14 x 0.5	10.0	140	4.6	40
27829	16 x 0.5	11.0	160	4.4	45
27830	19 x 0.5	11.0	180	4.1	45
27831	20 x 0.5	12.0	190	4.1	45
27832	24 x 0.5	13.0	225	3.8	55
27833	27 x 0.5	13.5	245	3.7	55
27834	32 x 0.5	14.0	280	3.5	55
27835	37 x 0.5	15.0	315	3.3	60
26365	2 x 0.75	6.5	50	11.3	25
26366	3 x 0.75	7.0	60	9.8	25
26367	4 x 0.75	7.5	70	8.9	30
26368	5 x 0.75	8.0	85	8.3	30
26369	7 x 0.75	8.5	105	7.4	35
26370	10 x 0.75	11.0	155	6.6	45
26371	12 x 0.75	11.5	175	6.2	45
26372	14 x 0.75	12.5	200	5.9	50
26373	16 x 0.75	13.0	225	5.6	50
26374	19 x 0.75	13.5	255	5.3	55
26375	20 x 0.75	14.5	275	5.2	55
26376	24 x 0.75	16.0	320	4.9	65
26377	27 x 0.75	16.0	350	4.7	65
26378	32 x 0.75	16.5	400	4.5	65
26379	37 x 0.75	18.0	460	4.3	75

Standard length 1000 m

SHF2 on request. Part number for SHF2 cables 4 + code from above table
→ 4xxxxx

Other sizes on request.

LKSM-HF

250 V

Armoured control and instrumentation cable

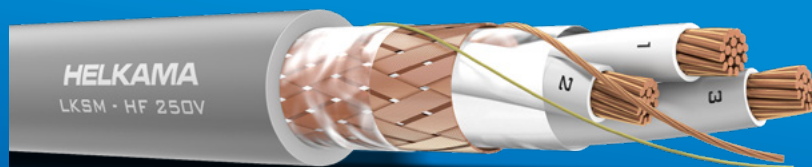

- Flame-retardant • Halogen-free • Low smoke emission • Oil resistant (SHF2 only)

CONDUCTOR	Stranded flexible copper conductor, IEC 60228 Class 5
INSULATION	XLPE
CABLING/BEDDING	Cabling, cores twisted together. Bedding, lapped tape.
ARMOUR	Copper drain wire (all sizes) Copper wire braid, coverage > 90% Tinned copper wire braid on request Armour serves as collective screen
SHEATH	Polyolefine SHF1, IEC 60092-360 Thermosetting polyolefine SHF2 on request Standard colour grey, other colours on request
REFERENCE STANDARD	IEC 60092-376

APPLICATION

Armoured control and instrumentation cable. For fixed installation in most areas, and on open deck in ships and offshore units. If the cable is exposed to direct sunlight, protective covering or cable with black outer sheath is recommended.

PHYSICAL PROPERTIES:

CORE IDENTIFICATION	Number code for core cables
MARINE TYPE APPROVALS	ABS, BV, CCS, CRS, DNV, KR, LR, RINA

MAIN CHARACTERISTICS:

RATED VOLTAGE	150/250 V (300 V)
FIRE PERFORMANCE	IEC 60332-1-2 IEC 60332-3-22
HALOGEN-FREE	IEC 60754 series
SMOKE EMISSION	IEC 61034 series
OIL RESISTANCE (SHF2 only)	IEC 60811-404 conditions according to 60092-360/SHF2
MIN. INSTALLATION TEMPERATURE	-15 °C
OPERATING TEMPERATURE	-40 - 80 °C fixed installation
MAXIMUM CONDUCTOR TEMPERATURE	90 °C

Subject to change without prior notice. See latest update on our webpage.

© 2022 Helkama Bica Oy. All rights reserved.

LKSM-HF 250 V

Part number	No. of conductors x Conductor area (mm ²)	Cross-section of armour mm ²	Nominal outer Ø (mm)	Weight kg/km	Current rating A	Min. bending radius mm (fixed)
27779	2 x 0.5	1.9	6.5	65	8.7	40
27780	3 x 0.5	1.9	6.5	70	7.6	40
27781	4 x 0.5	2.6	7.0	85	6.9	45
27782	5 x 0.5	2.6	7.5	95	6.4	45
27783	7 x 0.5	2.6	8.0	110	5.8	50
27784	10 x 0.5	3.3	10.0	150	5.1	60
27785	12 x 0.5	3.4	10.5	165	4.8	65
27786	14 x 0.5	3.6	11.0	185	4.6	65
27787	16 x 0.5	4.0	11.5	200	4.4	70
27788	19 x 0.5	4.1	12.0	230	4.1	75
27789	20 x 0.5	4.2	12.5	240	4.1	75
27790	24 x 0.5	4.8	14.0	280	3.8	85
27791	27 x 0.5	5.0	14.0	300	3.7	85
27792	32 x 0.5	10.1	15.0	390	3.5	90
27793	37 x 0.5	10.2	16.0	430	3.3	95
26402	2 x 0.75	2.1	7.0	75	11.3	45
26403	3 x 0.75	2.6	7.5	90	9.8	45
26404	4 x 0.75	2.6	8.0	100	8.9	50
26405	5 x 0.75	2.8	9.0	125	8.3	55
26407	7 x 0.75	3.3	9.5	150	7.4	60
26410	10 x 0.75	4.0	12.0	205	6.6	70
26412	12 x 0.75	4.2	12.5	225	6.2	75
26414	14 x 0.75	4.7	13.0	250	5.9	80
26416	16 x 0.75	4.7	13.5	275	5.6	80
26419	19 x 0.75	5.0	14.0	310	5.3	85
26420	20 x 0.75	10.1	15.5	385	5.2	95
26424	24 x 0.75	10.2	17.0	425	4.9	100
26427	27 x 0.75	10.2	17.0	455	4.7	105
26432	32 x 0.75	10.3	18.0	515	4.5	110
26437	37 x 0.75	11.2	19.0	575	4.3	115

Standard length 1000 m

SHF2 on request. Part number for SHF2 cables 4 + code from above table → 4xxxxx

Other sizes on request.

LKAM-HF

250 V

Screened control and instrumentation cable

250 V CABLES

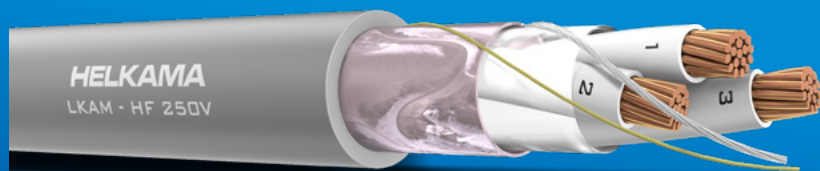

- Flame-retardant • Halogen-free • Low smoke emission • Oil resistant (SHF2 only)

CONDUCTOR	Stranded copper conductor, IEC 60228 Class 2
INSULATION	XLPE
CABLING	Cores twisted together, covered by separator tape.
SCREEN	Tinned copper drain wire (all sizes) Aluminium polyester tape, coverage 100%
SHEATH	Polyolefine SHF1, IEC 60092-360 Thermosetting polyolefine SHF2 on request Standard colour grey, other colours on request
REFERENCE STANDARD	IEC 60092-376

APPLICATION

Armoured control and instrumentation cable. For fixed installation in most areas, and on open deck in ships and offshore units. If the cable is exposed to direct sunlight, protective covering or cable with black outer sheath is recommended.

PHYSICAL PROPERTIES:

CORE IDENTIFICATION	Number code for core cables
MARINE TYPE APPROVALS	ABS, BV, CCS, CRS, DNV, KR, LR, RINA

MAIN CHARACTERISTICS:

RATED VOLTAGE	150/250 V (300 V)
FIRE PERFORMANCE	IEC 60332-1-2 IEC 60332-3-22
HALOGEN-FREE	IEC 60754 series
SMOKE EMISSION	IEC 61034 series
OIL RESISTANCE (SHF2 only)	IEC 60811-404 conditions according to 60092-360/SHF2
MIN. INSTALLATION TEMPERATURE	-15 °C
OPERATING TEMPERATURE	-40 – 80 °C fixed installation
MAXIMUM CONDUCTOR TEMPERATURE	90 °C

Subject to change without prior notice. See latest update on our webpage.

© 2022 Helkama Bica Oy. All rights reserved.

LKAM-HF 250 V

Part number	No. of conductors x Conductor area (mm ²)	Nominal outer Ø (mm)	Weight kg/km	Current rating A	Min. bending radius mm (fixed)
26440	2 x 0.5	5.5	40	8.7	45
26441	3 x 0.5	6.0	50	7.6	50
26442	4 x 0.5	6.5	60	6.9	50
26443	5 x 0.5	7.0	70	6.4	55
26444	7 x 0.5	7.5	80	5.8	60
26445	10 x 0.5	9.5	120	5.1	75
26446	12 x 0.5	10.0	130	4.8	80
26447	14 x 0.5	10.5	145	4.6	80
26448	16 x 0.5	11.0	165	4.4	85
26449	19 x 0.5	11.5	185	4.1	90
26450	20 x 0.5	12.0	205	4.1	95
26451	24 x 0.5	13.0	230	3.8	105
26452	27 x 0.5	13.5	250	3.7	110
26453	32 x 0.5	14.0	290	3.5	115
26454	37 x 0.5	15.0	330	3.3	120
26382	2 x 0.75	6.5	55	11.3	50
26383	3 x 0.75	7.0	65	9.8	55
26384	4 x 0.75	7.5	75	8.9	60
26385	5 x 0.75	8.0	90	8.3	65
26386	7 x 0.75	9.0	120	7.4	75
26387	10 x 0.75	11.0	160	6.6	90
26388	12 x 0.75	12.0	185	6.2	95
26389	14 x 0.75	12.5	205	5.9	100
26390	16 x 0.75	13.0	230	5.6	105
26391	19 x 0.75	13.5	260	5.3	110
26392	20 x 0.75	14.5	285	5.2	115
26393	24 x 0.75	16.0	325	4.9	125
26394	27 x 0.75	16.0	355	4.7	130
26395	32 x 0.75	17.0	415	4.5	135
26396	37 x 0.75	18.0	465	4.3	145
26397	61 x 0.75	19.5	655	3.6	160

Standard length 1000 m

SHF2 on request. Part number for SHF2 cables 4 + code from above table → 4xxxxx

Other sizes on request.

LKM-FRHF

250 V

Fire-resistant unarmoured control
and instrumentation cable

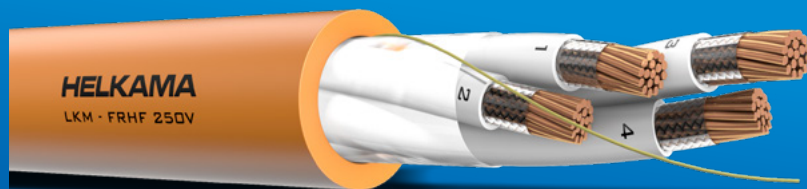

- Flame-retardant • Fire-resistant • Halogen-free • Low smoke emission • Oil resistant (SHF2 only)

CONDUCTOR	Stranded copper conductor, IEC 60228 Class 2
INSULATION	Mica tape XLPE
CABLING	Cores twisted together, covered by separator tape.
SHEATH	Polyolefine SHF1, IEC 60092-360 Thermosetting polyolefine SHF2 on request Standard colour orange, SHF2 standard colour black, other colours on request
REFERENCE STANDARD	IEC 60092-376

APPLICATION

Fire-resistant unarmoured control and instrumentation cable. For fixed installation in most areas, and on open deck in ships and offshore units. If the cable is exposed to direct sunlight, protective covering or cable with black outer sheath is recommended.

PHYSICAL PROPERTIES:

CORE IDENTIFICATION	Number code for core cables
MARINE TYPE APPROVALS	ABS, BV, CCS, CRS, DNV, KR, LR, RINA

MAIN CHARACTERISTICS:

RATED VOLTAGE	150/250 V (300 V)
FIRE PERFORMANCE	IEC 60332-1-2 IEC 60332-3-22
FIRE-RESISTANT	IEC 60331-1 / IEC 60331-2 (180 min)
HALOGEN-FREE	IEC 60754 series
SMOKE EMISSION	IEC 61034 series
OIL RESISTANCE (SHF2 only)	IEC 60811-404 conditions according to 60092-360/SHF2
MIN. INSTALLATION TEMPERATURE	-15 °C
OPERATING TEMPERATURE	-40 - 80 °C fixed installation
MAXIMUM CONDUCTOR TEMPERATURE	90 °C

Subject to change without prior notice. See latest update on our webpage.

© 2022 Helkama Bica Oy. All rights reserved.

LKM-FRHF 250 V

Part number	No. of conductors x Conductor area (mm ²)	Nominal outer Ø (mm)	Weight kg/km	Current rating A	Min. bending radius mm (fixed)
22406	2 x 0.75	8.0	65	11.3	35
22407	3 x 0.75	8.5	80	9.8	35
22408	4 x 0.75	9.5	95	8.9	40
22409	5 x 0.75	10.5	125	8.3	45
22410	7 x 0.75	11.5	155	7.4	45
22411	10 x 0.75	14.5	220	6.6	60
22412	12 x 0.75	15.0	250	6.2	60
22413	14 x 0.75	16.0	280	5.9	65
22414	16 x 0.75	17.0	315	5.6	65
22415	19 x 0.75	18.0	365	5.3	70
22416	20 x 0.75	19.0	395	5.2	75
22417	24 x 0.75	21.0	460	4.9	85
22418	27 x 0.75	21.5	500	4.7	85
22419	32 x 0.75	22.5	575	4.5	90
22420	37 x 0.75	24.5	675	4.3	100

Standard length 1000 m

SHF2 on request. Part number for SHF2 cables 4 + code from above table → 4xxxxx

Other sizes on request.

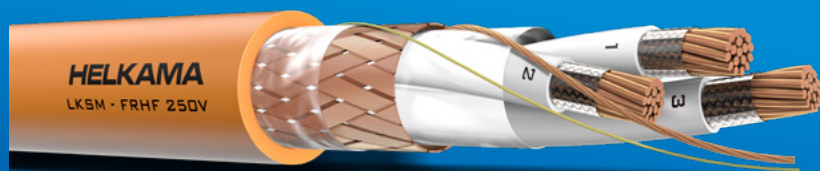

Photo credit: Fincantieri

LKSM-FRHF

250 V

Fire-resistant armoured control
and instrumentation cable



- Flame-retardant • Fire-resistant • Halogen-free • Low smoke emission • Oil resistant (SHF2 only)

CONDUCTOR	Stranded copper conductor, IEC 60228 Class 2
INSULATION	Mica tape XLPE
CABLING/BEDDING	Cabling, cores twisted together. Bedding lapped tape.
ARMOUR	Copper drain wire (all sizes) Copper wire braid, coverage > 90% Tinned copper wire braid on request Armour serves as collective screen
SHEATH	Polyolefine SHF1, IEC 60092-360 Thermosetting polyolefine SHF2 on request Standard colour orange, SHF2 standard colour black, other colours on request
REFERENCE STANDARD	IEC 60092-376

APPLICATION

Fire-resistant armoured control and instrumentation cable. For fixed installation in most areas, and on open deck in ships and offshore units. If the cable is exposed to direct sunlight, protective covering or cable with black outer sheath is recommended.

PHYSICAL PROPERTIES:

CORE IDENTIFICATION	Number code for core cables
MARINE TYPE APPROVALS	ABS, BV, CCS, CRS, DNV, KR, LR, RINA

MAIN CHARACTERISTICS:

RATED VOLTAGE	150/250 V (300 V)
FIRE PERFORMANCE	IEC 60332-1-2 IEC 60332-3-22
FIRE-RESISTANT	IEC 60331-1 / IEC 60331-2 (180 min)
HALOGEN-FREE	IEC 60754 series
SMOKE EMISSION	IEC 61034 series
OIL RESISTANCE (SHF2 only)	IEC 60811-404 conditions according to 60092-360/SHF2
MIN. INSTALLATION TEMPERATURE	-15 °C
OPERATING TEMPERATURE	-40 - 80 °C fixed installation
MAXIMUM CONDUCTOR TEMPERATURE	90 °C

Subject to change without prior notice. See latest update on our webpage.

© 2022 Helkama Bica Oy. All rights reserved.

LKSM-FRHF 250 V

Part number	No. of conductors x Conductor area (mm ²)	Cross-section of armour mm ²	Nominal outer Ø (mm)	Weight kg/km	Current rating A	Min. bending radius mm (fixed)
22436	2 x 0.75	2.2	9.0	90	11.3	55
22437	3 x 0.75	3.3	9.5	115	9.8	55
22438	4 x 0.75	3.4	10.5	145	8.9	65
22439	5 x 0.75	4.0	11.5	170	8.3	70
22440	7 x 0.75	4.2	12.0	200	7.4	75
22441	10 x 0.75	5.5	15.5	280	6.6	90
22442	12 x 0.75	5.7	16.0	310	6.2	95
22443	14 x 0.75	6.1	16.5	345	5.9	100
22444	16 x 0.75	10.4	18.0	430	5.6	110
22445	19 x 0.75	11.1	19.0	475	5.3	115
22446	20 x 0.75	11.8	20.0	525	5.2	120
22447	24 x 0.75	13.2	22.0	590	4.9	130
22448	27 x 0.75	13.5	22.5	635	4.7	135
22449	32 x 0.75	14.1	23.5	710	4.5	140
22450	37 x 0.75	15.3	25.5	825	4.3	150

Standard length 1000 m

SHF2 on request. Part number for SHF2 cables 4 + code from above table → 4xxxxx

Other sizes on request.

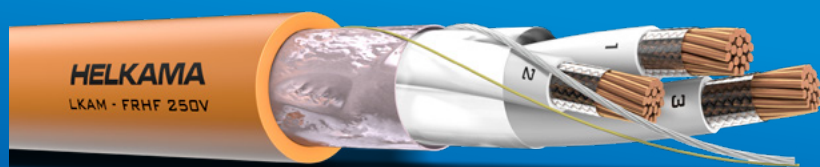

Photo credit: Arctech (Helsinki Shipyard since May 2019)

LKAM-FRHF

250 V

Fire-resistant screened control
and instrumentation cable



- Flame-retardant • Fire-resistant • Halogen-free • Low smoke emission • Oil resistant (SHF2 only)

CONDUCTOR	Stranded copper conductor, IEC 60228 Class 2
INSULATION	Mica tape XLPE
CABLING	Cabling, cores twisted together, covered by separator tape.
SCREEN	Tinned copper drain wire (all sizes) Aluminium polyester tape, coverage 100%
SHEATH	Polyolefine SHF1, IEC 60092-360 Thermosetting polyolefine SHF2 on request Standard colour orange, SHF2 standard colour black, other colours on request
REFERENCE STANDARD	IEC 60092-376

APPLICATION

Fire-resistant screened control and instrumentation cable. For fixed installation in most areas, and on open deck in ships and offshore units, especially when lightweight cables are needed. If the cable is exposed to direct sunlight, protective covering or cable with black outer sheath is recommended.

PHYSICAL PROPERTIES:

CORE IDENTIFICATION	Number code for core cables
MARINE TYPE APPROVALS	ABS, CCS, CRS, DNV, KR, LR, RINA

MAIN CHARACTERISTICS:

RATED VOLTAGE	150/250 V (300 V)
FIRE PERFORMANCE	IEC 60332-1-2 IEC 60332-3-22
FIRE-RESISTANT	IEC 60331-1 / IEC 60331-2 (180 min)
HALOGEN-FREE	IEC 60754 series
SMOKE EMISSION	IEC 61034 series
OIL RESISTANCE (SHF2 only)	IEC 60811-404 conditions according to 60092-360/SHF2
MIN. INSTALLATION TEMPERATURE	-15 °C
OPERATING TEMPERATURE	-40 - 80 °C fixed installation
MAXIMUM CONDUCTOR TEMPERATURE	90 °C

Subject to change without prior notice. See latest update on our webpage.

© 2022 Helkama Bica Oy. All rights reserved.

LKAM-FRHF 250 V

Part number	No. of conductors x Conductor area (mm ²)	Nominal outer Ø (mm)	Weight kg/km	Current rating A	Min. bending radius mm (fixed)
22466	2 x 0.75	8.0	70	11.3	65
22467	3 x 0.75	8.5	85	9.8	70
22468	4 x 0.75	10.0	110	8.9	80
22469	5 x 0.75	10.5	135	8.3	85
22470	7 x 0.75	11.5	160	7.4	95
22471	10 x 0.75	15.0	225	6.6	120
22472	12 x 0.75	15.5	255	6.2	120
22473	14 x 0.75	16.0	295	5.9	130
22474	16 x 0.75	17.0	330	5.6	135
22475	19 x 0.75	18.0	370	5.3	145
22476	20 x 0.75	19.0	405	5.2	150
22477	24 x 0.75	21.0	470	4.9	170
22478	27 x 0.75	21.5	510	4.7	175
22479	32 x 0.75	23.0	600	4.5	180
22480	37 x 0.75	24.5	680	4.3	195

Standard length 1000 m

SHF2 on request. Part number for SHF2 cables 4 + code from above table → 4xxxxx

Other sizes on request.

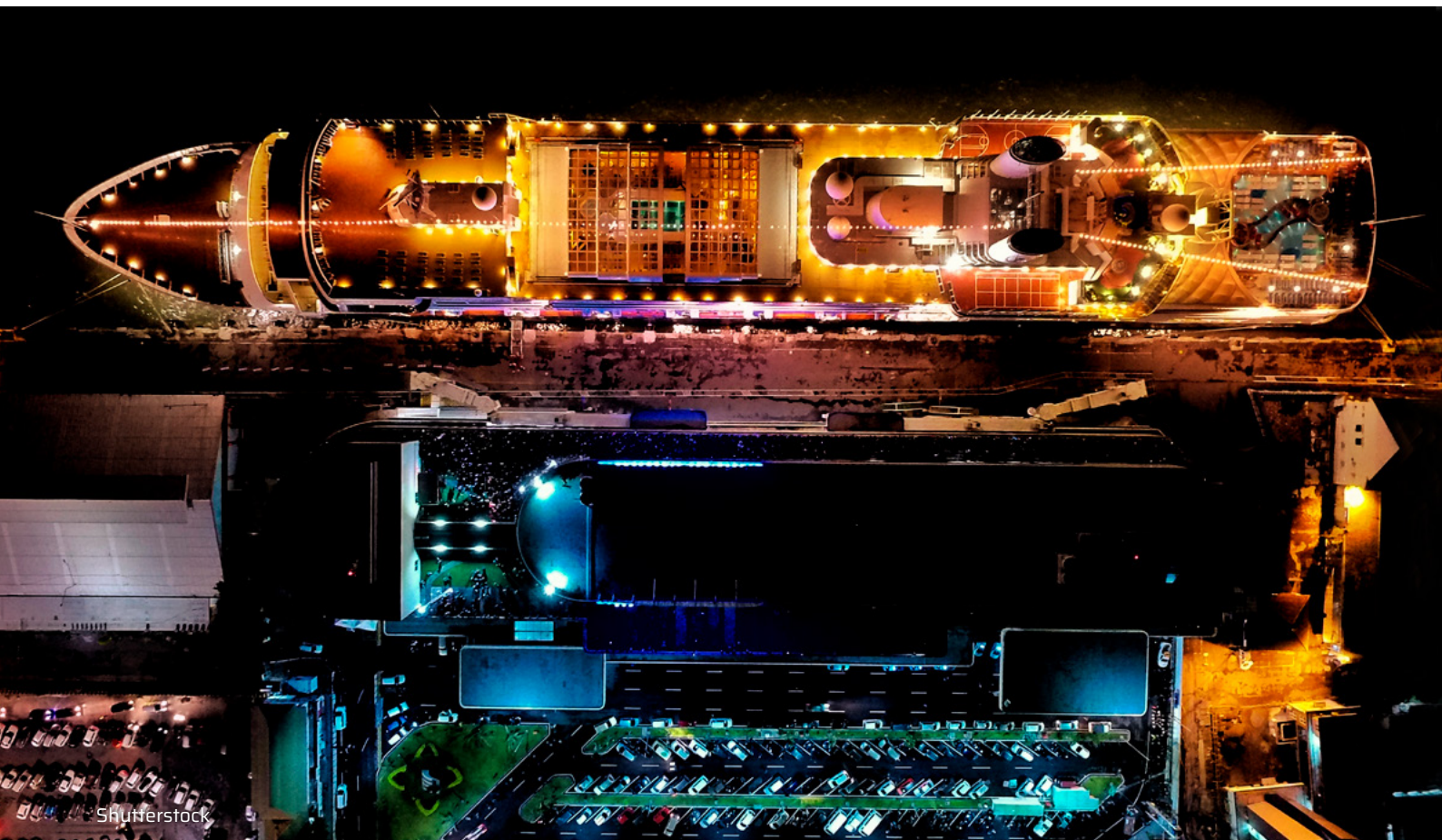

RFE-HF

250 V

Armoured pair instrumentation and communication cable

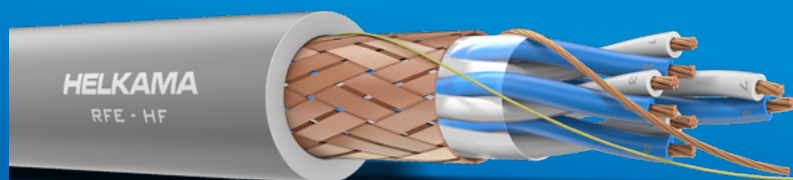

- Flame-retardant • Halogen-free • Low smoke emission • Oil resistant (SHF2 only)

CONDUCTOR	Stranded copper conductor, IEC 60228 Class 2
INSULATION	XLPE
TWISTED PAIR	Two insulated cores twisted together to form a pair
CABLING/BEDDING	Cabling, pairs twisted together, with optional fillers to obtain symmetrical and round construction. Bedding, lapped tape.
ARMOUR	Copper drain wire (all sizes) Copper wire braid, coverage > 90% Tinned copper wire braid on request Armour serves as collective screen
SHEATH	Polyolefine SHF1, IEC 60092-360 Thermosetting polyolefine SHF2 on request Standard colour grey, other colours on request
REFERENCE STANDARD	IEC 60092-376

APPLICATION

Armoured pair instrumentation and communication cable. For fixed installation in most areas, and on open deck in ships and offshore units. If the cable is exposed to direct sunlight, protective covering or cable with black outer sheath is recommended.

PHYSICAL PROPERTIES:

CORE IDENTIFICATION	Pair colours white and blue Pair identification with colour code and identification number
MARINE TYPE APPROVALS	ABS, BV, CCS, CRS, DNV, KR, LR, RINA

MAIN CHARACTERISTICS:

RATED VOLTAGE	150/250 V (300 V)
FIRE PERFORMANCE	IEC 60332-1-2 IEC 60332-3-22
HALOGEN-FREE	IEC 60754 series
SMOKE EMISSION	IEC 61034 series
OIL RESISTANCE (SHF2 only)	IEC 60811-404 conditions according to 60092-360/SHF2
MIN. INSTALLATION TEMPERATURE	-15 °C
OPERATING TEMPERATURE	-40 - 80 °C fixed installation
MAXIMUM CONDUCTOR TEMPERATURE	90 °C

Subject to change without prior notice. See latest update on our webpage.

© 2022 Helkama Bica Oy. All rights reserved.

ELECTRICAL PROPERTIES:

	0.5 mm ²	0.75 mm ²	1.5 mm ²	Unit
Loop resistance (pair, max 20 °C)	80	52	24.4	ohm/km
Pair capacitance (nom. 1 KHz)	55	50	60	nF/km
Loop inductance (nom.)	0.6	0.6	0.7	mH/km
Insulation resistance (20 °C)	≥ 1500	≥ 1500	≥ 1500	Mohm/km

RFE-HF 250 V

Part number	No. of conductors x Conductor area (mm ²)	Nominal outer Ø (mm)	Weight kg/km	Min. bending radius mm (fixed)
20362	1 x 2 x 0.5	6.5	65	40
---	1 x 3 x 0.5	7.0	80	40
20364	2 x 2 x 0.5 Quad	7.5	85	45
20363	2 x 2 x 0.5	9.5	115	55
20365	3 x 2 x 0.5	10.0	125	60
20366	4 x 2 x 0.5	10.5	145	65
20368	7 x 2 x 0.5	12.5	205	75
20369	8 x 2 x 0.5	13.0	230	80
20370	10 x 2 x 0.5	15.5	320	90
20371	12 x 2 x 0.5	16.0	350	95
20372	14 x 2 x 0.5	17.0	385	100
20373	16 x 2 x 0.5	18.0	425	110
20374	19 x 2 x 0.5	19.0	480	115
20376	24 x 2 x 0.5	21.5	585	130
20377	32 x 2 x 0.5	24.0	735	145
20378	37 x 2 x 0.5	25.5	815	155
20382	1 x 2 x 0.75	7.5	85	45
---	1 x 3 x 0.75	8.0	95	45
20384	2 x 2 x 0.75 Quad	8.5	105	50
20383	2 x 2 x 0.75	11.0	140	65
20385	3 x 2 x 0.75	11.5	160	70
20386	4 x 2 x 0.75	12.5	195	75
20388	7 x 2 x 0.75	14.5	275	90
20389	8 x 2 x 0.75	16.0	355	95
20390	10 x 2 x 0.75	18.0	415	110
20391	12 x 2 x 0.75	19.0	460	115
20392	14 x 2 x 0.75	20.0	515	120
20393	16 x 2 x 0.75	21.5	590	130
20394	19 x 2 x 0.75	23.0	665	140
20396	24 x 2 x 0.75	25.5	805	155
20398	32 x 2 x 0.75	29.0	1015	175
20399	37 x 2 x 0.75	31.0	1165	185
20490	1 x 2 x 1.5	9.0	115	55
---	1 x 3 x 1.5	10.0	135	60
20491	2 x 2 x 1.5 Quad	10.0	160	60
20492	2 x 2 x 1.5	13.5	220	80
---	3 x 2 x 1.5	14.0	250	85
20493	4 x 2 x 1.5	16.0	355	95
20494	7 x 2 x 1.5	19.0	505	115
20495	8 x 2 x 1.5	20.5	580	125
20496	10 x 2 x 1.5	23.5	705	140
20497	12 x 2 x 1.5	24.5	795	145
20498	14 x 2 x 1.5	26.0	895	155
20503	16 x 2 x 1.5	27.5	1005	165
20499	19 x 2 x 1.5	29.5	1145	175
20500	24 x 2 x 1.5	33.0	1430	200

Standard length 1000 m

SHF2 on request. Part number for SHF2 cables 4 + code from above table → 4xxxxx

Other sizes on request.

RFE-HF (i)

250 V

Armoured and individually screened pair instrumentation and communication cable

250 V CABLES

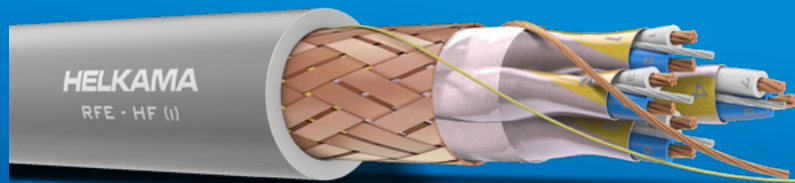

- Flame-retardant • Halogen-free • Low smoke emission • Oil resistant (SHF2 only)

CONDUCTOR	Stranded copper conductor, IEC 60228 Class 2
INSULATION	XLPE
TWISTED PAIR & INDIVIDUAL SCREEN	Two insulated cores twisted together to form a pair Aluminium polyester tape and tinned copper drain wire
CABLING/BEDDING	Cabling, pairs twisted together, with optional fillers to obtain symmetrical and round construction. Bedding, lapped tape.
ARMOUR	Copper drain wire (all sizes) Copper wire braid, coverage > 90% Tinned copper wire braid on request Armour serves as collective screen
SHEATH	Polyolefine SHF1, IEC 60092-360 Thermosetting polyolefine SHF2 on request Standard colour grey, other colours on request
REFERENCE STANDARD	IEC 60092-376

APPLICATION

Armoured and individually screened pair instrumentation and communication cable. For fixed installation in most areas, and on open deck in ships and offshore units. If the cable is exposed to direct sunlight, protective covering or cable with black outer sheath is recommended.

PHYSICAL PROPERTIES:

CORE IDENTIFICATION	Pair colours white and blue Pair identification with colour code and identification number
MARINE TYPE APPROVALS	ABS, BV, CCS, CRS, DNV, KR, LR, RINA

MAIN CHARACTERISTICS:

RATED VOLTAGE	150/250 V (300 V)
FIRE PERFORMANCE	IEC 60332-1-2 IEC 60332-3-22
HALOGEN-FREE	IEC 60754 series
SMOKE EMISSION	IEC 61034 series
OIL RESISTANCE (SHF2 only)	IEC 60811-404 conditions according to 60092-360/SHF2
MIN. INSTALLATION TEMPERATURE	-15 °C
OPERATING TEMPERATURE	-40 - 80 °C fixed installation
MAXIMUM CONDUCTOR TEMPERATURE	90 °C

Subject to change without prior notice. See latest update on our webpage.

© 2022 Helkama Bica Oy. All rights reserved.

ELECTRICAL PROPERTIES:

	0.5 mm ²	0.75 mm ²	1.5 mm ²	Unit
Loop resistance (pair, max 20 °C)	80	52	24.4	ohm/km
Pair capacitance (nom. 1 KHz)	55	50	60	nF/km
Loop inductance (nom.)	0.6	0.6	0.7	mH/km
Insulation resistance (20 °C)	≥ 1500	≥ 1500	≥ 1500	Mohm/km

RFE-HF (i) 250 V

Part number	No. of conductors x Conductor area (mm ²)	Nominal outer Ø (mm)	Weight kg/km	Min. bending radius mm (fixed)
22338	1 x 2 x 0.5	6.5	70	40
22340	1 x 3 x 0.5	6.7	100	40
22342	2 x 2 x 0.5 Quad	7.0	120	42
22344	2 x 2 x 0.5	9.5	130	55
22346	3 x 2 x 0.5	10.0	145	60
22348	4 x 2 x 0.5	11.0	170	65
22350	7 x 2 x 0.5	12.5	250	75
22352	8 x 2 x 0.5	13.5	275	80
22354	10 x 2 x 0.5	15.5	380	95
22356	12 x 2 x 0.5	16.5	425	100
22358	14 x 2 x 0.5	17.5	475	105
22360	16 x 2 x 0.5	18.5	520	110
22362	19 x 2 x 0.5	19.5	590	115
22364	24 x 2 x 0.5	22.0	740	130
22370	32 x 2 x 0.5	24.5	925	150
22372	37 x 2 x 0.5	26.5	1050	160
22006	1 x 2 x 0.75	7.5	90	45
22005	1 x 3 x 0.75	7.5	110	45
22008	2 x 2 x 0.75 Quad	8.0	145	50
22010	2 x 2 x 0.75	11.0	155	65
22096	3 x 2 x 0.75	11.5	185	70
22012	4 x 2 x 0.75	12.5	220	75
22014	7 x 2 x 0.75	15.5	370	90
22016	8 x 2 x 0.75	16.5	400	100
22018	10 x 2 x 0.75	18.5	475	110
22020	12 x 2 x 0.75	19.0	535	115
22022	14 x 2 x 0.75	21.0	620	125
22094	16 x 2 x 0.75	22.0	685	130
22024	19 x 2 x 0.75	23.5	795	140
22026	24 x 2 x 0.75	26.0	965	155
22028	32 x 2 x 0.75	29.5	1235	180
22031	37 x 2 x 0.75	31.5	1390	190
22050	1 x 2 x 1.5	9.5	130	55
22049	1 x 3 x 1.5	10.0	120	55
22052	2 x 2 x 1.5 Quad	10.0	210	60
22054	2 x 2 x 1.5	13.5	235	80
22093	3 x 2 x 1.5	15.0	335	90
22056	4 x 2 x 1.5	16.0	390	95
22058	7 x 2 x 1.5	19.0	565	115
22060	8 x 2 x 1.5	21.0	650	125
22062	10 x 2 x 1.5	23.5	790	140
22064	12 x 2 x 1.5	24.5	895	150
22066	14 x 2 x 1.5	26.5	1025	160
22095	16 x 2 x 1.5	28.0	1140	165
22068	19 x 2 x 1.5	30.5	1340	180
22070	24 x 2 x 1.5	33.5	1650	200

Standard length 1000 m

SHF2 on request. Part number for SHF2 cables 4 + code from above table → 4xxxxx

Other sizes on request.

RFE-EMC

250 V

Armoured pair instrumentation and communication cable with improved EMC-screening

250 V CABLES

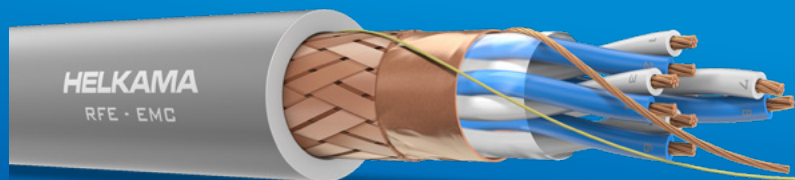

- Flame-retardant • Halogen-free • Low smoke emission • Oil resistant (SHF2 only)

CONDUCTOR	Stranded copper conductor, IEC 60228 Class 2
INSULATION	XLPE
TWISTED PAIR	Two insulated cores twisted together to form a pair
CABLING/BEDDING	Cabling, pairs twisted together, with optional fillers to obtain symmetrical and round construction. Bedding, lapped tape.
SCREEN	Copper drain wire (all sizes) Copper tape, coverage 100%
ARMOUR	Copper wire braid, coverage > 90%, IEC 60092-350 Tinned copper wire braid on request Armour serves as collective screen
SHEATH	Polyolefine SHF1, IEC 60092-360 Thermosetting polyolefine SHF2 on request Standard colour grey, other colours on request
REFERENCE STANDARD	IEC 60092-376

APPLICATION

Armoured pair instrumentation and communication cable with improved EMC-screening. For fixed installation in most areas, and on open deck in ships and offshore units. If the cable is exposed to direct sunlight, protective covering or cable with black outer sheath is recommended. Specially designed cables with screen for improved screening properties to address EMI/EMC problems.

PHYSICAL PROPERTIES:

CORE IDENTIFICATION Pair colours white and blue
Pair identification with colour code and identification number

MARINE TYPE APPROVALS ABS, CRS, DNV, LR, RINA

MAIN CHARACTERISTICS:

RATED VOLTAGE 150/250 V (300 V)

FIRE PERFORMANCE IEC 60332-1-2
IEC 60332-3-22

HALOGEN-FREE IEC 60754 series

SMOKE EMISSION IEC 61034 series

OIL RESISTANCE (SHF2 only) IEC 60811-404 conditions according to 60092-360/SHF2

MIN. INSTALLATION TEMPERATURE -15 °C

OPERATING TEMPERATURE -40 - 80 °C fixed installation

MAXIMUM CONDUCTOR TEMPERATURE 90 °C

Subject to change without prior notice. See latest update on our webpage.

© 2022 Helkama Bica Oy. All rights reserved.

ELECTRICAL PROPERTIES:

	0.5 mm ²	0.75 mm ²	1.5 mm ²	Unit
Loop resistance (pair, max 20 °C)	80	52	24.4	ohm/km
Pair capacitance (nom. 1 KHz)	55	50	60	nF/km
Loop inductance (nom.)	0.6	0.6	0.7	mH/km
Insulation resistance (20 °C)	≥ 1500	≥ 1500	≥ 1500	Mohm/km

RFE-EMC 250 V

Part number	No. of conductors x Conductor area (mm ²)	Nominal outer Ø (mm)	Weight kg/km	Min. bending radius mm (fixed)
21968	1 x 2 x 0.5	8.0	90	65
21969	1 x 3 x 0.5	8.5	100	65
21970	2 x 2 x 0.5 Quad	9.0	115	70
21971	2 x 2 x 0.5	11.0	140	85
21972	3 x 2 x 0.5	11.5	160	90
21973	4 x 2 x 0.5	12.0	180	95
21974	7 x 2 x 0.5	14.0	245	110
21975	8 x 2 x 0.5	14.5	265	115
21976	10 x 2 x 0.5	16.5	360	135
21977	12 x 2 x 0.5	17.0	395	135
21978	14 x 2 x 0.5	18.0	430	145
21979	16 x 2 x 0.5	19.0	475	155
21980	19 x 2 x 0.5	20.5	530	165
21981	24 x 2 x 0.5	22.5	645	180
21982	27 x 2 x 0.5	23.5	700	190
21983	30 x 2 x 0.5	24.5	755	195
21984	32 x 2 x 0.5	25.5	800	200
21985	37 x 2 x 0.5	26.5	890	215
21987	1 x 2 x 0.75	9.0	105	70
21988	1 x 3 x 0.75	9.0	125	75
21989	2 x 2 x 0.75 Quad	10.0	140	80
21990	2 x 2 x 0.75	12.0	175	95
21991	3 x 2 x 0.75	12.5	195	100
21992	4 x 2 x 0.75	14.0	230	110
21993	7 x 2 x 0.75	16.0	315	125
21994	8 x 2 x 0.75	17.0	395	140
21995	10 x 2 x 0.75	19.5	465	155
21996	12 x 2 x 0.75	20.0	515	160
21997	14 x 2 x 0.75	21.5	570	170
21998	16 x 2 x 0.75	22.5	650	180
21999	19 x 2 x 0.75	24.0	730	195
22000	24 x 2 x 0.75	26.5	875	215
22001	27 x 2 x 0.75	28.0	965	225
22002	30 x 2 x 0.75	29.5	1045	235
22003	32 x 2 x 0.75	30.0	1095	240
22004	37 x 2 x 0.75	32.0	1250	260
22375	1 x 2 x 1.5	10.5	150	85
22376	1 x 3 x 1.5	11.0	180	90
22377	2 x 2 x 1.5 Quad	11.5	210	95
22378	2 x 2 x 1.5	14.5	255	115
22379	3 x 2 x 1.5	15.0	290	120
22380	4 x 2 x 1.5	17.0	390	135
22381	7 x 2 x 1.5	20.0	550	160
22382	8 x 2 x 1.5	21.5	625	170
22383	10 x 2 x 1.5	24.0	755	195
22384	12 x 2 x 1.5	25.0	845	200
22385	14 x 2 x 1.5	26.5	945	215
22386	16 x 2 x 1.5	28.0	1060	225
22387	19 x 2 x 1.5	30.0	1205	240
22388	24 x 2 x 1.5	33.5	1495	270

Standard length 1000 m

SHF2 on request. Part number for SHF2 cables 4 + code from above table → 4xxxxx

Other sizes on request.

RFE-EMC (i)

250 V

Armoured and individually screened pair instrumentation and communication cable with improved EMC-screening

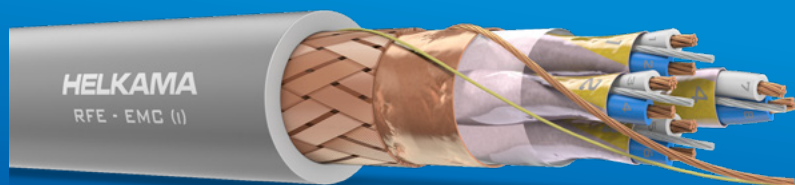

- Flame-retardant • Halogen-free • Low smoke emission • Oil resistant (SHF2 only)

CONDUCTOR	Stranded copper conductor, IEC 60228 Class 2
INSULATION	XLPE
TWISTED PAIR & INDIVIDUAL SCREEN	Two insulated cores twisted together to form a pair Aluminium polyester tape and tinned copper drain wire
CABLING/BEDDING	Cabling, pairs twisted together, with optional fillers to obtain symmetrical and round construction. Bedding, lapped tape.
SCREEN	Copper drain wire (all sizes) Copper tape, coverage 100%
ARMOUR	Copper wire braid, coverage > 90% Tinned copper wire braid on request Armour serves as collective screen
SHEATH	Polyolefine SHF1, IEC 60092-360 Thermosetting polyolefine SHF2 on request Standard colour grey, other colours on request
REFERENCE STANDARD	IEC 60092-376

APPLICATION

Armoured and individually screened pair instrumentation and communication cable with improved EMC-screening. For fixed installation in most areas, and on open deck in ships and offshore units. If the cable is exposed to direct sunlight, protective covering or cable with black outer sheath is recommended. Specially designed cables with screen for improved screening properties to address EMI/EMC problems.

PHYSICAL PROPERTIES:

CORE IDENTIFICATION	Pair colours white and blue Pair identification with colour code and identification number
MARINE TYPE APPROVALS	ABS, CRS, DNV, LR, RINA

MAIN CHARACTERISTICS:

RATED VOLTAGE	150/250 V (300 V)
FIRE PERFORMANCE	IEC 60332-1-2 IEC 60332-3-22
HALOGEN-FREE	IEC 60754 series
SMOKE EMISSION	IEC 61034 series
OIL RESISTANCE (SHF2 only)	IEC 60811-404 conditions according to 60092-360/SHF2
MIN. INSTALLATION TEMPERATURE	-15 °C
OPERATING TEMPERATURE	-40 - 80 °C fixed installation
MAXIMUM CONDUCTOR TEMPERATURE	90 °C

ELECTRICAL PROPERTIES:

	0.5 mm ²	0.75 mm ²	1.5 mm ²	Unit
Loop resistance (pair, max 20 °C)	80	52	24.4	ohm/km
Pair capacitance (nom. 1 KHz)	55	70	90	nF/km
Loop inductance (nom.)	0.6	0.6	0.7	mH/km
Insulation resistance (20 °C)	≥ 1500	≥ 1500	≥ 1500	Mohm/km

RFE-HF (i) 250 V

Part number	No. of conductors x Conductor area (mm ²)	Nominal outer Ø (mm)	Weight kg/km	Min. bending radius mm (fixed)
21949	1 x 2 x 0.5	8.0	105	65
21950	1 x 3 x 0.5	8.5	115	65
21951	2 x 2 x 0.5 Quad	9.0	130	70
21952	2 x 2 x 0.5	11.0	165	90
21953	3 x 2 x 0.5	11.5	190	90
21954	4 x 2 x 0.5	12.5	220	100
21955	7 x 2 x 0.5	14.0	315	115
21956	8 x 2 x 0.5	15.5	395	120
21957	10 x 2 x 0.5	17.0	460	135
21958	12 x 2 x 0.5	17.5	515	140
21959	14 x 2 x 0.5	18.5	585	150
21960	16 x 2 x 0.5	19.5	640	155
21961	19 x 2 x 0.5	21.0	730	165
21962	24 x 2 x 0.5	23.0	905	185
21963	27 x 2 x 0.5	24.0	990	195
21964	30 x 2 x 0.5	25.0	1075	200
21965	32 x 2 x 0.5	26.0	1130	205
21966	37 x 2 x 0.5	27.5	1280	220
21911	1 x 2 x 0.75	9.0	110	70
21912	1 x 3 x 0.75	9.5	130	75
21913	2 x 2 x 0.75 Quad	10.0	140	80
21914	2 x 2 x 0.75	12.5	190	100
21915	3 x 2 x 0.75	13.0	225	105
21916	4 x 2 x 0.75	14.0	255	110
21917	7 x 2 x 0.75	17.0	405	135
21918	8 x 2 x 0.75	17.5	440	140
21919	10 x 2 x 0.75	20.0	530	160
21920	12 x 2 x 0.75	20.5	590	165
21921	14 x 2 x 0.75	22.0	680	175
21922	16 x 2 x 0.75	23.0	745	185
21923	19 x 2 x 0.75	25.0	860	200
21924	24 x 2 x 0.75	27.5	1035	220
21925	27 x 2 x 0.75	28.5	1135	230
21926	30 x 2 x 0.75	30.0	1260	240
21927	32 x 2 x 0.75	31.0	1320	250
21928	37 x 2 x 0.75	33.0	1480	260
21930	1 x 2 x 1.5	11.0	160	85
21931	1 x 3 x 1.5	11.0	185	90
21932	2 x 2 x 1.5 Quad	12.0	215	95
21933	2 x 2 x 1.5	15.0	275	120
21934	3 x 2 x 1.5	16.5	370	130
21935	4 x 2 x 1.5	17.5	430	140
21936	7 x 2 x 1.5	20.5	625	165
21937	8 x 2 x 1.5	22.0	710	175
21938	10 x 2 x 1.5	24.0	850	195
21939	12 x 2 x 1.5	26.0	970	205
21940	14 x 2 x 1.5	27.5	1105	220
21941	16 x 2 x 1.5	29.0	1220	235
21942	19 x 2 x 1.5	31.5	1430	250
21943	24 x 2 x 1.5	35.0	1750	280

Standard length 1000 m

SHF2 on request. Part number for SHF2 cables 4 + code from above table → 4xxxxx

Other sizes on request.

RFA-HF

250 V

Screened pair instrumentation and communication cable

250 V CABLES

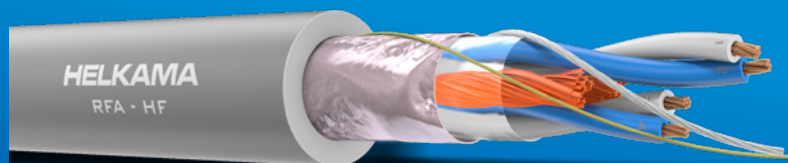

- Flame-retardant • Halogen-free • Low smoke emission • Oil resistant (SHF2 only)

CONDUCTOR	Stranded copper conductor, IEC 60228 Class 2
INSULATION	XLPE
TWISTED PAIR	Two insulated cores twisted together to form a pair
CABLING	Cabling, pairs twisted together, with optional fillers to obtain symmetrical and round construction, covered by separator tape.
COLLECTIVE SCREEN	Tinned copper drain wire (all sizes) Aluminium polyester tape, coverage 100%
SHEATH	Polyolefine SHF1, IEC 60092-360 Thermosetting polyolefine SHF2 on request Standard colour grey, other colours on request
REFERENCE STANDARD	IEC 60092-376

APPLICATION

Screened pair instrumentation and communication cable. For fixed installation in most areas, and on open deck in ships and offshore units, especially when lightweight cables are needed. If the cable is exposed to direct sunlight, protective covering or cable with black outer sheath is recommended.

PHYSICAL PROPERTIES:

CORE IDENTIFICATION	Pair colours white and blue Pair identification with colour code and identification number
MARINE TYPE APPROVALS	ABS, BV, CCS, CRS, DNV, KR, LR, RINA

MAIN CHARACTERISTICS:

RATED VOLTAGE	150/250 V (300 V)
FIRE PERFORMANCE	IEC 60332-1-2 IEC 60332-3-22
HALOGEN-FREE	IEC 60754 series
SMOKE EMISSION	IEC 61034 series
OIL RESISTANCE (SHF2 only)	IEC 60811-404 conditions according to 60092-360/SHF2
MIN. INSTALLATION TEMPERATURE	-15 °C
OPERATING TEMPERATURE	-40 - 80 °C fixed installation
MAXIMUM CONDUCTOR TEMPERATURE	90 °C

Subject to change without prior notice. See latest update on our webpage.

© 2022 Helkama Bica Oy. All rights reserved.

ELECTRICAL PROPERTIES:

	0.5 mm ²	0.75 mm ²	1.5 mm ²	Unit
Loop resistance (pair, max 20 °C)	80	52	24.4	ohm/km
Pair capacitance (nom. 1 KHz)	55	50	60	nF/km
Loop inductance (nom.)	0.6	0.6	0.7	mH/km
Insulation resistance (20 °C)	≥ 1500	≥ 1500	≥ 1500	Mohm/km

RFA-HF 250 V

Part number	No. of conductors x Conductor area (mm ²)	Nominal outer Ø (mm)	Weight kg/km	Min. bending radius mm (fi xed)
20910	1 x 2 x 0.5	5.5	40	45
20904	1 x 3 x 0.5	6.0	50	50
20912	2 x 2 x 0.5 Quad	6.5	60	50
20914	2 x 2 x 0.5	8.0	70	65
20906	3 x 2 x 0.5	8.5	85	70
20916	4 x 2 x 0.5	9.5	110	80
20918	7 x 2 x 0.5	11.5	155	90
20920	8 x 2 x 0.5	12.5	180	100
20922	10 x 2 x 0.5	14.0	215	110
20924	12 x 2 x 0.5	14.5	245	115
20926	14 x 2 x 0.5	15.5	280	125
20928	16 x 2 x 0.5	16.5	310	130
20930	19 x 2 x 0.5	17.5	360	140
20932	24 x 2 x 0.5	19.5	440	160
20934	32 x 2 x 0.5	22.5	580	180
20936	37 x 2 x 0.5	24.0	655	195
20970	1 x 2 x 0.75	6.5	55	50
20966	1 x 3 x 0.75	7.0	65	55
20972	2 x 2 x 0.75 Quad	7.5	75	60
20974	2 x 2 x 0.75	10.0	100	80
20968	3 x 2 x 0.75	10.5	120	85
20976	4 x 2 x 0.75	11.5	145	90
20978	7 x 2 x 0.75	14.0	220	110
20980	8 x 2 x 0.75	15.0	250	120
20982	10 x 2 x 0.75	16.5	300	135
20984	12 x 2 x 0.75	17.5	345	140
20986	14 x 2 x 0.75	19.0	400	150
20988	16 x 2 x 0.75	20.0	445	160
20990	19 x 2 x 0.75	22.0	530	175
20992	24 x 2 x 0.75	24.0	655	195
20994	32 x 2 x 0.75	27.5	845	220
20996	37 x 2 x 0.75	29.5	955	235
21356	1 x 2 x 1.5	8.0	80	65
21357	1 x 3 x 1.5	8.5	100	65
21358	2 x 2 x 1.5 Quad	9.5	130	75
21359	2 x 2 x 1.5	12.5	170	100
21360	3 x 2 x 1.5	13.5	200	105
21361	4 x 2 x 1.5	14.5	245	115
21362	7 x 2 x 1.5	17.5	385	140
21363	8 x 2 x 1.5	19.0	440	150
21364	10 x 2 x 1.5	22.0	555	175
21365	12 x 2 x 1.5	23.0	640	185
21366	14 x 2 x 1.5	24.5	735	195
21367	16 x 2 x 1.5	26.0	825	210
21368	19 x 2 x 1.5	28.0	970	225
21369	24 x 2 x 1.5	31.5	1210	255
21370	27 x 2 x 1.5	33.5	1355	270

Standard length 1000 m

SHF2 on request. Part number for SHF2 cables 4 + code from above table → 4xxxxx

Other sizes on request.

RFA-HF (i)

250 V

Collectively and individually screened pair instrumentation and communication cable

250 V CABLES

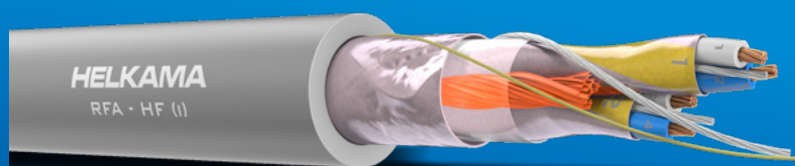

- Flame-retardant • Halogen-free • Low smoke emission • Oil resistant (SHF2 only)

CONDUCTOR	Stranded copper conductor, IEC 60228 Class 2
INSULATION	XLPE
TWISTED PAIR & INDIVIDUAL SCREEN	Two insulated cores twisted together to form a pair Aluminium polyester tape and tinned copper drain wire
CABLING	Cabling, pairs twisted together, with optional fillers to obtain symmetrical and round construction, covered by separator tape.
COLLECTIVE SCREEN	Tinned copper drain wire (all sizes) Aluminium polyester tape, coverage 100%
SHEATH	Polyolefine SHF1, IEC 60092-360 Thermosetting polyolefine SHF2 on request Standard colour grey, other colours on request
REFERENCE STANDARD	IEC 60092-376

APPLICATION

Collectively and individually screened pair instrumentation and communication cable. For fixed installation in most areas, and on open deck in ships and offshore units, especially when lightweight cables are needed. If the cable is exposed to direct sunlight, protective covering or cable with black outer sheath is recommended.

PHYSICAL PROPERTIES:

CORE IDENTIFICATION	Pair colours white and blue Pair identification with colour code and identification number
MARINE TYPE APPROVALS	ABS, BV, CCS, CRS, DNV, KR, LR, RINA

MAIN CHARACTERISTICS:

RATED VOLTAGE	150/250 V (300 V)
FIRE PERFORMANCE	IEC 60332-1-2 IEC 60332-3-22
HALOGEN-FREE	IEC 60754 series
SMOKE EMISSION	IEC 61034 series
OIL RESISTANCE (SHF2 only)	IEC 60811-404 conditions according to 60092-360/SHF2
MIN. INSTALLATION TEMPERATURE	-15 °C
OPERATING TEMPERATURE	-40 - 80 °C fixed installation
MAXIMUM CONDUCTOR TEMPERATURE	90 °C

Subject to change without prior notice. See latest update on our webpage.

© 2022 Helkama Bica Oy. All rights reserved.

ELECTRICAL PROPERTIES:

	0.5 mm ²	0.75 mm ²	1.5 mm ²	Unit
Loop resistance (pair, max 20 °C)	80	52	24.4	ohm/km
Pair capacitance (nom. 1 KHz)	55	70	90	nF/km
Loop inductance (nom.)	0.6	0.6	0.7	mH/km
Insulation resistance (20 °C)	≥ 1500	≥ 1500	≥ 1500	Mohm/km

RFA-HF (i) 250 V

Part number	No. of conductors x Conductor area (mm ²)	Nominal outer Ø (mm)	Weight kg/km	Min. bending radius mm (fixed)
20939	1 x 2 x 0.5	6.0	50	45
---	1 x 3 x 0.5	9.0	85	70
---	2 x 2 x 0.5 Quad	9.5	100	80
20940	2 x 2 x 0.5	8.5	85	65
20942	4 x 2 x 0.5	10.0	130	80
20944	7 x 2 x 0.5	12.0	200	95
20946	8 x 2 x 0.5	12.5	225	100
20948	10 x 2 x 0.5	14.5	280	115
20950	12 x 2 x 0.5	15.0	320	120
20952	14 x 2 x 0.5	16.0	360	130
20954	16 x 2 x 0.5	17.0	405	135
20956	19 x 2 x 0.5	18.5	475	145
20958	24 x 2 x 0.5	20.5	600	165
20960	32 x 2 x 0.5	23.5	775	185
20962	37 x 2 x 0.5	25.0	880	200
21058	1 x 2 x 0.75	6.5	60	55
23408	1 x 3 x 0.75	10.5	100	85
21079	2 x 2 x 0.75 Quad	11.5	120	90
21059	2 x 2 x 0.75	10.0	115	80
21100	3 x 2 x 0.75	10.5	135	85
21061	4 x 2 x 0.75	11.5	170	95
21115	5 x 2 x 0.75	13.0	205	105
21063	7 x 2 x 0.75	14.0	260	110
21065	8 x 2 x 0.75	15.0	300	120
21067	10 x 2 x 0.75	17.0	370	140
21069	12 x 2 x 0.75	18.0	425	145
21071	14 x 2 x 0.75	19.0	480	155
21073	16 x 2 x 0.75	20.5	560	165
21075	19 x 2 x 0.75	22.0	645	180
21077	24 x 2 x 0.75	24.5	795	200
21375	1 x 2 x 1.5	8.0	90	65
21376	1 x 3 x 1.5	13.0	150	100
21377	2 x 2 x 1.5 Quad	14.5	195	115
21378	2 x 2 x 1.5	12.5	185	100
21379	3 x 2 x 1.5	13.0	225	105
21380	4 x 2 x 1.5	14.5	285	120
21381	7 x 2 x 1.5	17.5	450	140
21382	8 x 2 x 1.5	19.5	520	155
21383	10 x 2 x 1.5	22.0	645	175
21384	12 x 2 x 1.5	23.0	740	185
21385	14 x 2 x 1.5	24.5	845	195
21386	16 x 2 x 1.5	26.0	960	210
21387	19 x 2 x 1.5	28.0	1115	225
21388	24 x 2 x 1.5	31.5	1415	255
21389	27 x 2 x 1.5	33.5	1585	270

Standard length 1000 m

SHF2 on request. Part number for SHF2 cables 4 + code from above table → 4xxxxx

Other sizes on request.

RFE-FRHF

250 V

Fire-resistant armoured pair instrumentation
and communication cable

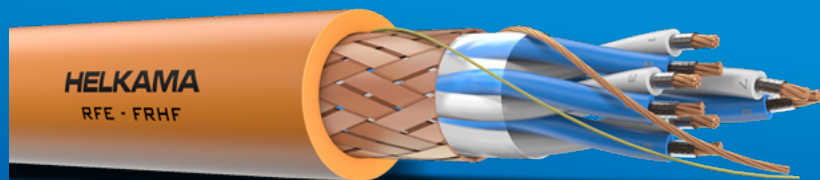

- Flame-retardant • Fire-resistant • Halogen-free • Low smoke emission • Oil resistant (SHF2 only)

CONDUCTOR	Stranded copper conductor, IEC 60228 Class 2
INSULATION	Mica tape
TWISTED PAIR	Two insulated cores twisted together to form a pair
CABLING/BEDDING	Cabling, pairs twisted together, with optional fillers to obtain symmetrical and round construction. Bedding, lapped tape.
ARMOUR	Copper drain wire (all sizes) Copper wire braid, coverage > 90% Tinned copper wire braid on request Armour serves as collective screen
SHEATH	Polyolefine SHF1, IEC 60092-360 Thermosetting polyolefine SHF2 on request Standard colour orange, SHF2 standard colour black, other colours on request
REFERENCE STANDARD	IEC 60092-376

APPLICATION

Fire-resistant armoured pair instrumentation and communication cable. For fixed installation in most areas, and on open deck in ships and offshore units. If the cable is exposed to direct sunlight, protective covering or cable with black outer sheath is recommended.

PHYSICAL PROPERTIES:

CORE IDENTIFICATION Pair colours white and blue
Pair identification with colour code and identification number

MARINE TYPE APPROVALS ABS, BV, CCS, CRS, DNV, KR, LR, RINA

MAIN CHARACTERISTICS:

RATED VOLTAGE	150/250 V (300 V)
FIRE PERFORMANCE	IEC 60332-1-2 IEC 60332-3-22
FIRE-RESISTANT	IEC 60331-1/IEC 60331-2 (180 min)
HALOGEN-FREE	IEC 60754 series
SMOKE EMISSION	IEC 61034 series
OIL RESISTANCE (SHF2 only)	IEC 60811-404 conditions according to 60092-360/SHF2
MIN. INSTALLATION TEMPERATURE	-15 °C
OPERATING TEMPERATURE	-40 - 80 °C fixed installation
MAXIMUM CONDUCTOR TEMPERATURE	90 °C

Subject to change without prior notice. See latest update on our webpage.

© 2022 Helkama Bica Oy. All rights reserved.

ELECTRICAL PROPERTIES:

	0.75 mm ²	1.5 mm ²	Unit
Loop resistance (pair, max 20 °C)	52	24.4	ohm/km
Pair capacitance (nom. 1 KHz)	45	55	nF/km
Loop inductance (nom.)	0.6	0.7	mH/km
Insulation resistance (20 °C)	≥ 1500	≥ 1500	Mohm/km

RFE-FRHF 250 V

Part number	No. of conductors x Conductor area (mm ²)	Nominal outer Ø (mm)	Weight kg/km	Min. bending radius mm (fixed)
20520	1 x 2 x 0.75	9.0	105	55
20522	2 x 2 x 0.75 Quad	10.5	150	65
20524	2 x 2 x 0.75	13.5	195	80
20526	4 x 2 x 0.75	16.0	265	95
20528	7 x 2 x 0.75	19.5	430	115
20530	8 x 2 x 0.75	21.0	485	125
20532	10 x 2 x 0.75	24.0	600	145
20534	12 x 2 x 0.75	25.0	670	150
20536	14 x 2 x 0.75	26.5	750	160
20538	19 x 2 x 0.75	30.5	955	180
20540	24 x 2 x 0.75	34.0	1185	205
20575	1 x 2 x 1.5	10.0	135	60
20577	2 x 2 x 1.5 Quad	11.5	195	70
20579	2 x 2 x 1.5	15.5	310	90
20574	3 x 2 x 1.5	16.0	340	95
20581	4 x 2 x 1.5	17.5	395	105
20583	7 x 2 x 1.5	21.5	600	130
20585	8 x 2 x 1.5	22.5	660	135
20587	10 x 2 x 1.5	25.5	805	155
20589	12 x 2 x 1.5	27.0	925	160
20591	14 x 2 x 1.5	29.0	1040	175
20593	16 x 2 x 1.5	31.0	1180	185
20595	19 x 2 x 1.5	33.0	1350	200

Standard length 1000 m

SHF2 on request. Part number for SHF2 cables 4 + code from above table → 4xxxxx

Other sizes on request.

RFE-FRHF (i)

250 V

Fire-resistant armoured and individually screened pair instrumentation and communication cable

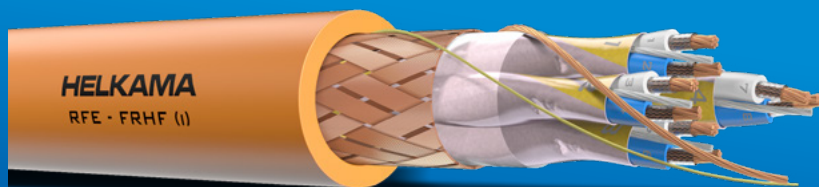

- Flame-retardant • Fire-resistant • Halogen-free • Low smoke emission • Oil resistant (SHF2 only)

CONDUCTOR	Stranded copper conductor, IEC 60228 Class 2
INSULATION	Mica tape XLPE
TWISTED PAIR & INDIVIDUAL SCREEN	Two insulated cores twisted together to form a pair Aluminium polyester tape and tinned copper drain wire
CABLING/BEDDING	Cabling, pairs twisted together, with optional fillers to obtain symmetrical and round construction. Bedding, lapped tape.
ARMOUR	Copper drain wire (all sizes) Copper wire braid, coverage > 90% Tinned copper wire braid on request Armour serves as collective screen
SHEATH	Polyolefine SHF1, IEC 60092-360 Thermosetting polyolefine SHF2 on request Standard colour orange, SHF2 standard colour black, other colours on request
REFERENCE STANDARD	IEC 60092-376

APPLICATION

Fire-resistant armoured and individually screened pair instrumentation and communication cable. For fixed installation in most areas, and on open deck in ships and offshore units. If the cable is exposed to direct sunlight, protective covering or cable with black outer sheath is recommended.

PHYSICAL PROPERTIES:

CORE IDENTIFICATION	Pair colours white and blue Pair identification with colour code and identification number
MARINE TYPE APPROVALS	ABS, BV, CCS, CRS, DNV, KR, LR, RINA

MAIN CHARACTERISTICS:

RATED VOLTAGE	150/250 V (300 V)
FIRE PERFORMANCE	IEC 60332-1-2 IEC 60332-3-22
FIRE-RESISTANT	IEC 60331-1/IEC 60331-2 (180 min)
HALOGEN-FREE	IEC 60754 series
SMOKE EMISSION	IEC 61034 series
OIL RESISTANCE (SHF2 only)	IEC 60811-404 conditions according to 60092-360/SHF2
MIN. INSTALLATION TEMPERATURE	-15 °C
OPERATING TEMPERATURE	-40 - 80 °C fixed installation
MAXIMUM CONDUCTOR TEMPERATURE	90 °C

ELECTRICAL PROPERTIES:

	0.75 mm ²	1.5 mm ²	Unit
Loop resistance (pair, max 20 °C)	52	24.4	ohm/km
Pair capacitance (nom. 1 KHz)	55	75	nF/km
Loop inductance (nom.)	0.6	0.7	mH/km
Insulation resistance (20 °C)	≥ 1500	≥ 1500	Mohm/km

RFE-FRHF (i) 250 V

Part number	No. of conductors x Conductor area (mm ²)	Nominal outer Ø (mm)	Weight kg/km	Min. bending radius mm (fixed)
20546	1 x 2 x 0.75	9.0	110	55
20548	2 x 2 x 0.75 Quad	11.0	180	65
20550	2 x 2 x 0.75	14.0	215	85
20552	4 x 2 x 0.75	16.5	345	100
20554	7 x 2 x 0.75	20.0	490	120
20556	8 x 2 x 0.75	21.0	540	125
20558	10 x 2 x 0.75	24.0	670	145
20560	12 x 2 x 0.75	25.5	760	155
20562	14 x 2 x 0.75	27.0	855	165
20563	16 x 2 x 0.75	29.0	960	175
20564	19 x 2 x 0.75	31.0	1095	185
20566	24 x 2 x 0.75	34.5	1360	210
20603	1 x 2 x 1.5	10.5	150	65
20604	2 x 2 x 1.5 Quad	12.0	240	70
20605	2 x 2 x 1.5	16.0	325	95
20607	4 x 2 x 1.5	18.5	460	110
20609	7 x 2 x 1.5	22.5	695	135
20611	8 x 2 x 1.5	24.0	780	145
20613	10 x 2 x 1.5	27.5	955	165
20615	12 x 2 x 1.5	29.0	1110	175
20617	14 x 2 x 1.5	31.0	1250	185
20619	16 x 2 x 1.5	33.0	1410	200
20621	19 x 2 x 1.5	35.5	1615	210

Standard length 1000 m

SHF2 on request. Part number for SHF2 cables 4 + code from above table → 4xxxxx

Other sizes on request.

RFE-EMC-FRHF

250 V

Fire-resistant armoured pair instrumentation and communication cable with improved collective EMC-screening

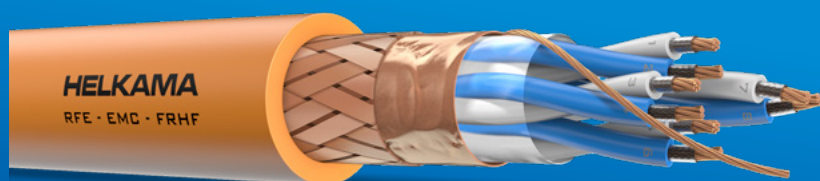

- Flame-retardant • Halogen-free • Low smoke emission • Oil resistant (SHF2 only)

CONDUCTOR	Stranded copper conductor, IEC 60228 Class 2
INSULATION	Mica tape XLPE
TWISTED PAIR	Two insulated cores twisted together to form a pair
CABLING/BEDDING	Cabling, pairs twisted together, with optional fillers to obtain symmetrical and round construction. Bedding, lapped tape.
SCREEN	Copper drain wire (all sizes) Copper tape, coverage 100%
ARMOUR	Copper wire braid, coverage > 90% Tinned copper wire braid on request Armour serves as collective screen
SHEATH	Polyolefine SHF1, IEC 60092-360 Thermosetting polyolefine SHF2 on request Standard colour orange, SHF2 standard colour black, other colours on request
REFERENCE STANDARD	IEC 60092-376

APPLICATION

Fire-resistant armoured pair instrumentation and communication cable with improved collective EMC-screening. For fixed installation in most areas, and on open deck in ships and offshore units. If the cable is exposed to direct sunlight, protective covering or cable with black outer sheath is recommended. Specially designed cables with screen for improved screening properties to address EMI/EMC problems.

PHYSICAL PROPERTIES:

CORE IDENTIFICATION Pair colours white and blue
Pair identification with colour code and identification number

MARINE TYPE APPROVALS ABS, BV, DNV

MAIN CHARACTERISTICS:

RATED VOLTAGE	150/250 V (300 V)
FIRE PERFORMANCE	IEC 60332-1-2 IEC 60332-3-22
FIRE-RESISTANT	IEC 60331-1/IEC 60331-2 (180 min)
HALOGEN-FREE	IEC 60754 series
SMOKE EMISSION	IEC 61034 series
OIL RESISTANCE (SHF2 only)	IEC 60811-404 conditions according to 60092-360/SHF2
MIN. INSTALLATION TEMPERATURE	-15 °C
OPERATING TEMPERATURE	-40 - 80 °C fixed installation
MAXIMUM CONDUCTOR TEMPERATURE	90 °C

ELECTRICAL PROPERTIES:

	0.75 mm ²	1.5 mm ²	Unit
Loop resistance (pair, max 20 °C)	52	24.4	ohm/km
Pair capacitance (nom. 1 KHz)	45	55	nF/km
Loop inductance (nom.)	0.6	0.7	mH/km
Insulation resistance (20 °C)	≥ 1500	≥ 1500	Mohm/km

RFE-EMC-FRHF 250 V

Part number	No. of conductors x Conductor area (mm ²)	Nominal outer Ø (mm)	Weight kg/km	Min. bending radius mm (fixed)
22915	1 x 2 x 0.75	9.5	120	75
22917	2 x 2 x 0.75 Quad	11.0	170	90
22918	2 x 2 x 0.75	14.0	225	115
22919	3 x 2 x 0.75	15.0	250	120
22920	4 x 2 x 0.75	16.5	300	130
22921	7 x 2 x 0.75	20.0	475	160
22922	8 x 2 x 0.75	21.5	530	170
22923	10 x 2 x 0.75	24.5	655	195
22924	12 x 2 x 0.75	25.5	720	205
22925	14 x 2 x 0.75	27.0	805	215
22926	16 x 2 x 0.75	29.0	895	230
22927	19 x 2 x 0.75	31.0	1015	245
22928	24 x 2 x 0.75	34.5	1255	275
22929	27 x 2 x 0.75	36.5	1370	290
22930	30 x 2 x 0.75	38.0	1500	305
22931	32 x 2 x 0.75	39.0	1575	315
22934	1 x 2 x 1.5	11.0	165	85
22936	2 x 2 x 1.5 Quad	12.0	225	100
22937	2 x 2 x 1.5	16.5	350	130
22938	3 x 2 x 1.5	17.5	385	140
22939	4 x 2 x 1.5	19.0	450	150
22940	7 x 2 x 1.5	23.0	680	185
22941	8 x 2 x 1.5	24.0	750	195
22942	10 x 2 x 1.5	27.5	925	220
22943	12 x 2 x 1.5	29.0	1040	230
22944	14 x 2 x 1.5	31.0	1165	245
22945	16 x 2 x 1.5	33.0	1325	265
22946	19 x 2 x 1.5	35.5	1510	280

Standard length 1000 m

SHF2 on request. Part number for SHF2 cables 4 + code from above table → 4xxxxx

Other sizes on request.

RFE-EMC-FRHF (i)

250 V

Fire-resistant armoured and individually screened pair instrumentation and communication cable with improved collective EMC-screening

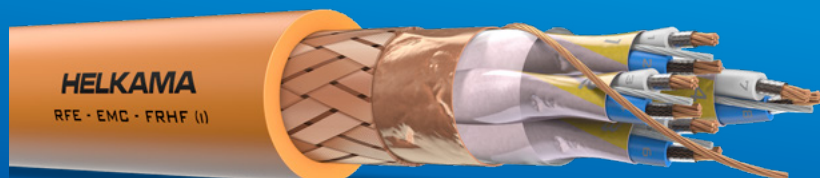

- Flame-retardant • Halogen-free • Low smoke emission • Oil resistant (SHF2 only)

CONDUCTOR	Stranded copper conductor, IEC 60228 Class 2
INSULATION	Mica tape XLPE
TWISTED PAIR & INDIVIDUAL SCREEN	Two insulated cores twisted together to form a pair Aluminium polyester tape and tinned copper drain wire
CABLING/BEDDING	Cabling, pairs twisted together, with optional fillers to obtain symmetrical and round construction. Bedding, lapped tape.
ARMOUR	Copper wire braid, coverage > 90% Tinned copper wire braid on request Armour serves as collective screen
SHEATH	Polyolefine SHF1, IEC 60092-360 Thermosetting polyolefine SHF2 on request Standard colour grey, other colours on request
REFERENCE STANDARD	IEC 60092-376

APPLICATION

Fire-resistant armoured and individually screened pair instrumentation and communication cable with improved collective EMC-screening. For fixed installation in most areas, and on open deck in ships and offshore units. If the cable is exposed to direct sunlight, protective covering or cable with black outer sheath is recommended. Specially designed cables with screen for improved screening properties to address EMI/EMC problems.

PHYSICAL PROPERTIES:

CORE IDENTIFICATION Pair colours white and blue
Pair identification with colour code and identification number

MARINE TYPE APPROVALS ABS, BV, DNV

MAIN CHARACTERISTICS:

RATED VOLTAGE	150/250 V (300 V)
FIRE PERFORMANCE	IEC 60332-1-2 IEC 60332-3-22
FIRE-RESISTANT	IEC 60331-1/IEC 60331-2 (180 min.)
HALOGEN-FREE	IEC 60754 series
SMOKE EMISSION	IEC 61034 series
OIL RESISTANCE (SHF2 only)	IEC 60811-404 conditions according to 60092-360/SHF2
MIN. INSTALLATION TEMPERATURE	-15 °C
OPERATING TEMPERATURE	-40 - 80 °C fixed installation
MAXIMUM CONDUCTOR TEMPERATURE	90 °C

ELECTRICAL PROPERTIES:

	0.75 mm ²	1.5 mm ²	Unit
Loop resistance (pair, max 20 °C)	52	24.4	ohm/km
Pair capacitance (nom. 1 KHz)	55	75	nF/km
Loop inductance (nom.)	0.6	0.7	mH/km
Insulation resistance (20 °C)	≥ 1500	≥ 1500	Mohm/km

RFE-EMC-FRHF (i) 250 V

Part number	No. of conductors x Conductor area (mm ²)	Nominal outer Ø (mm)	Weight kg/km	Min. bending radius mm (fixed)
22858	1 x 2 x 0.75	10.5	135	85
22860	2 x 2 x 0.75 Quad	12.0	190	95
22861	2 x 2 x 0.75	15.0	240	120
22862	3 x 2 x 0.75	16.0	280	125
22863	4 x 2 x 0.75	18.0	380	140
22864	7 x 2 x 0.75	21.0	535	170
22865	8 x 2 x 0.75	22.0	585	180
22866	10 x 2 x 0.75	25.5	720	200
22867	12 x 2 x 0.75	26.5	815	215
22868	14 x 2 x 0.75	28.0	910	225
22869	16 x 2 x 0.75	30.0	1020	240
22870	19 x 2 x 0.75	32.0	1155	255
22871	24 x 2 x 0.75	36.0	1430	285
22877	1 x 2 x 1.5	11.5	180	95
22879	2 x 2 x 1.5 Quad	13.0	245	105
22880	2 x 2 x 1.5	17.5	360	140
22881	3 x 2 x 1.5	18.0	415	145
22882	4 x 2 x 1.5	20.0	505	160
22883	7 x 2 x 1.5	23.5	750	190
22884	8 x 2 x 1.5	25.0	840	200
22885	10 x 2 x 1.5	28.5	1020	230
22886	12 x 2 x 1.5	30.0	1180	240
22887	14 x 2 x 1.5	32.0	1330	255
22888	16 x 2 x 1.5	34.0	1485	270
22889	19 x 2 x 1.5	36.5	1700	290

Standard length 1000 m

SHF2 on request. Part number for SHF2 cables 4 + code from above table → 4xxxxx

Other sizes on request.

RFA-FRHF

250 V

Fire-resistant screened pair instrumentation
and communication cable

250 V CABLES

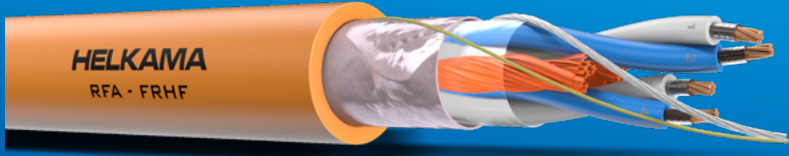

- Flame-retardant • Fire-resistant • Halogen-free • Low smoke emission • Oil resistant (SHF2 only)

CONDUCTOR	Stranded copper conductor, IEC 60228 Class 2
INSULATION	Mica tape XLPE
TWISTED PAIR	Two insulated cores twisted together to form a pair
CABLING	Cabling, pairs twisted together, with optional fillers to obtain symmetrical and round construction, covered by separator tape
COLLECTIVE SCREEN	Tinned copper drain wire (all sizes) Aluminium polyester tape, coverage 100%
SHEATH	Polyolefine SHF1, IEC 60092-360 Thermosetting polyolefine SHF2 on request Standard colour orange, SHF2 standard colour black, other colours on request
REFERENCE STANDARD	IEC 60092-376

APPLICATION

Fire-resistant screened pair instrumentation and communication cable. For fixed installation in most areas, and on open deck in ships and offshore units, especially when lightweight cables are needed. If the cable is exposed to direct sunlight, protective covering or cable with black outer sheath is recommended.

PHYSICAL PROPERTIES:

CORE IDENTIFICATION	Pair colours white and blue Pair identification with colour code and identification number
MARINE TYPE APPROVALS	ABS, BV, CCS, CRS, DNV, KR, LR, RINA

MAIN CHARACTERISTICS:

RATED VOLTAGE	150/250 V (300 V)
FIRE PERFORMANCE	IEC 60332-1-2 IEC 60332-3-22
FIRE-RESISTANT	IEC 60331-1 / IEC 60331-2 (180 min)
HALOGEN-FREE	IEC 60754 series
SMOKE EMISSION	IEC 61034 series
OIL RESISTANCE (SHF2 only)	IEC 60811-404 conditions according to 60092-360/SHF2
MIN. INSTALLATION TEMPERATURE	-15 °C
OPERATING TEMPERATURE	-40 - 80 °C fixed installation
MAXIMUM CONDUCTOR TEMPERATURE	90 °C

Subject to change without prior notice. See latest update on our webpage.

© 2022 Helkama Bica Oy. All rights reserved.

ELECTRICAL PROPERTIES:

	0.75 mm ²	1.5 mm ²	Unit
Loop resistance (pair, max 20 °C)	52	24.4	ohm/km
Pair capacitance (nom. 1 KHz)	45	55	nF/km
Loop inductance (nom.)	0.6	0.7	mH/km
Insulation resistance (20 °C)	≥ 1500	≥ 1500	Mohm/km

RFA-FRHF 250 V

Part number	No. of conductors x Conductor area (mm ²)	Nominal outer Ø (mm)	Weight kg/km	Min. bending radius mm (fixed)
20635	1 x 2 x 0.75	8.0	70	65
20637	2 x 2 x 0.75 Quad	9.5	100	75
20639	2 x 2 x 0.75	13.0	145	100
20641	4 x 2 x 0.75	15.0	210	120
20643	7 x 2 x 0.75	18.0	315	145
20645	8 x 2 x 0.75	19.5	355	155
20647	10 x 2 x 0.75	22.5	435	180
20649	12 x 2 x 0.75	23.5	500	185
20651	14 x 2 x 0.75	25.5	590	205
20653	16 x 2 x 0.75	27.0	655	215
20655	19 x 2 x 0.75	29.0	770	235
20657	24 x 2 x 0.75	32.5	955	260
21521	1 x 2 x 1.5	9.0	95	75
21523	1 x 3 x 1.5	10.0	130	80
21524	2 x 2 x 1.5 Quad	11.0	160	85
21525	2 x 2 x 1.5	14.5	210	115
21526	3 x 2 x 1.5	15.5	240	125
21527	4 x 2 x 1.5	17.0	305	135
21529	7 x 2 x 1.5	20.5	480	165
21531	8 x 2 x 1.5	22.5	555	180
21533	10 x 2 x 1.5	26.0	685	205
21535	12 x 2 x 1.5	27.0	790	215
21537	14 x 2 x 1.5	29.0	910	230
21539	16 x 2 x 1.5	31.0	1020	245
21541	19 x 2 x 1.5	33.5	1210	270

Standard length 1000 m

SHF2 on request. Part number for SHF2 cables 4 + code from above table → 4xxxxx

Other sizes on request.

RFA-FRHF (i)

250 V

Fire-resistant collectively and individually screened pair instrumentation and communication cable

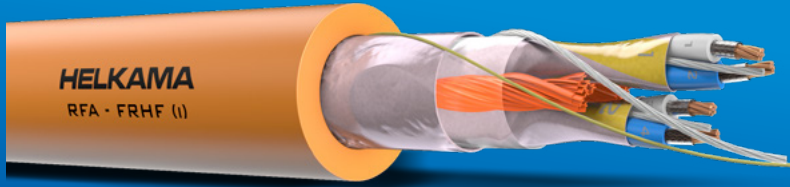

- Flame-retardant • Fire-resistant • Halogen-free • Low smoke emission • Oil resistant (SHF2 only)

CONDUCTOR	Stranded copper conductor, IEC 60228 Class 2
INSULATION	Mica tape XLPE
TWISTED PAIR & INDIVIDUAL SCREEN	Two insulated cores twisted together to form a pair Aluminium polyester tape and tinned copper drain wire
CABLING	Cabling, pairs twisted together, with optional fillers to obtain symmetrical and round construction, covered by separator tape
COLLECTIVE SCREEN	Tinned copper drain wire (all sizes) Aluminium polyester tape, coverage 100%
SHEATH	Polyolefine SHF1, IEC 60092-360 Thermosetting polyolefine SHF2 on request Standard colour orange, SHF2 standard colour black, other colours on request
REFERENCE STANDARD	IEC 60092-376

APPLICATION

Fire-resistant collectively and individually screened pair instrumentation and communication cable. For fixed installation in most areas, and on open deck in ships and offshore units, especially when lightweight cables are needed. If the cable is exposed to direct sunlight, protective covering or cable with black outer sheath is recommended.

PHYSICAL PROPERTIES:

CORE IDENTIFICATION	Pair colours white and blue Pair identification with colour code and identification number
MARINE TYPE APPROVALS	ABS, BV, CCS, CRS, DNV, KR, LR, RINA

MAIN CHARACTERISTICS:

RATED VOLTAGE	150/250 V (300 V)
FIRE PERFORMANCE	IEC 60332-1-2 IEC 60332-3-22
FIRE-RESISTANT	IEC 60331-1 / IEC 60331-2 (180 min)
HALOGEN-FREE	IEC 60754 series
SMOKE EMISSION	IEC 61034 series
OIL RESISTANCE (SHF2 only)	IEC 60811-404 conditions according to 60092-360/SHF2
MIN. INSTALLATION TEMPERATURE	-15 °C
OPERATING TEMPERATURE	-40 - 80 °C fixed installation
MAXIMUM CONDUCTOR TEMPERATURE	90 °C

Subject to change without prior notice. See latest update on our webpage.

© 2022 Helkama Bica Oy. All rights reserved.

ELECTRICAL PROPERTIES:

	0.75 mm ²	1.5 mm ²	Unit
Loop resistance (pair, max 20 °C)	52	24.4	ohm/km
Pair capacitance (nom. 1 KHz)	55	75	nF/km
Loop inductance (nom.)	0.6	0.7	mH/km
Insulation resistance (20 °C)	≥ 1500	≥ 1500	Mohm/km

RFA-FRHF (i) 250 V

Part number	No. of conductors x Conductor area (mm ²)	Nominal outer Ø (mm)	Weight kg/km	Min. bending radius mm (fixed)
20664	1 x 2 x 0.75	8.5	80	65
20666	2 x 2 x 0.75 Quad	6.0	110	50
20667	2 x 2 x 0.75	13.0	155	105
20668	3 x 2 x 0.75	14.0	190	110
20669	4 x 2 x 0.75	15.5	235	120
20671	7 x 2 x 0.75	18.5	365	150
20673	8 x 2 x 0.75	20.0	415	160
20675	10 x 2 x 0.75	23.0	525	185
20677	12 x 2 x 0.75	24.0	600	195
20679	14 x 2 x 0.75	25.5	680	205
20681	16 x 2 x 0.75	27.5	775	220
20683	19 x 2 x 0.75	29.5	890	235
20685	24 x 2 x 0.75	33.5	1135	265
21550	1 x 2 x 1.5	9.0	105	75
21552	2 x 2 x 1.5 Quad	7.0	165	55
21553	2 x 2 x 1.5	14.5	230	115
21554	3 x 2 x 1.5	16.0	275	125
21555	4 x 2 x 1.5	17.5	340	140
21557	7 x 2 x 1.5	21.0	540	170
21559	8 x 2 x 1.5	23.0	630	180
21561	10 x 2 x 1.5	26.5	790	210
21563	12 x 2 x 1.5	27.5	910	220
21565	14 x 2 x 1.5	29.5	1040	235
21567	16 x 2 x 1.5	31.5	1195	250
21569	19 x 2 x 1.5	34.0	1400	275

Standard length 1000 m

SHF2 on request. Part number for SHF2 cables 4 + code from above table → 4xxxxx

Other sizes on request.

RFE-FRHF+WSR/WJR

250 V

Fire-resistant + Water Spray Resistant and/or Water Jet Resistant armoured pair instrumentation and communication cable

250 V CABLES

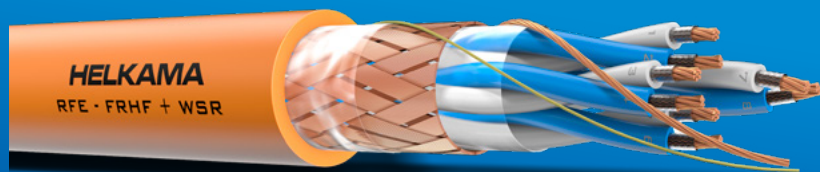

- Flame-retardant • Fire-resistant • Halogen-free • Low smoke emission • Water Spray and/or Water Jet Resistant

CONDUCTOR	Stranded copper conductor, IEC 60228 Class 2
INSULATION	Special grade Mica tape XLPE
TWISTED PAIR	Two insulated cores twisted together to form a pair
CABLING/BEDDING	Cabling, pairs twisted together, with optional fillers to obtain symmetrical and round construction. Bedding, lapped tape.
ARMOUR	Copper drain wire (all sizes) Copper wire braid, coverage > 90% Tinned copper wire braid on request Armour serves as collective screen
SHEATH	Polyolefine SHF1, IEC 60092-360 Thermosetting polyolefine SHF2 on request Standard colour orange, SHF2 standard colour black, other colours on request
REFERENCE STANDARD	IEC 60092-376

APPLICATION

Fire-resistant + Water Spray Resistant and/or Water Jet Resistant armoured pair instrumentation and communication cable. For fixed installation in most areas, and on open deck in ships and offshore units. Especially intended to ensure availability of all critical transportation-, comfort- and safety systems, i.e. to meet the concepts of; **Orderly Evacuation** (3 hours burning time) and **Safe Return to Port** (Fire test with simultaneous Water Spray / Water Jet + mechanical shocks) to simulate firefighting conditions.

If the cable is exposed to direct sunlight, protective covering or cable with black outer sheath is recommended.

PHYSICAL PROPERTIES:

CABLE TYPES	Cable Ø ≤20 mm RFE-FRHF+WSR Cable Ø >20 mm RFE-FRHF+WJR
CORE IDENTIFICATION	Pair colours white and blue Pair identification with colour code and identification number
MARINE TYPE APPROVALS	DNV, LR, RINA

MAIN CHARACTERISTICS:

RATED VOLTAGE	150/250 V (300 V)
FIRE PERFORMANCE	IEC 60332-1-2 IEC 60332-3-22
HALOGEN-FREE	IEC 60754 series
SMOKE EMISSION	IEC 61034 series
FIRE- AND WATER SPRAY RESISTANT (WSR)	IEC 60331-2 + EN 50200 Annex E (180 min)
FIRE- AND WATER JET RESISTANT (WJR)	IEC 60331-1 + BS 8491 (180 min)
OIL RESISTANCE (SHF2 only)	IEC 60811-404 conditions according to 60092-360/SHF2
MIN. INSTALLATION TEMPERATURE	-15 °C
OPERATING TEMPERATURE	-40 - 80 °C fixed installation
MAXIMUM CONDUCTOR TEMPERATURE	90 °C

ELECTRICAL PROPERTIES:

	0.75 mm ²	1.5 mm ²	Unit
Loop resistance (pair, max 20 °C)	52	24.4	ohm/km
Pair capacitance (nom. 1 KHz)	45	55	nF/km
Loop inductance (nom.)	0.6	0.7	mH/km
Insulation resistance (20 °C)	≥ 1500	≥ 1500	Mohm/km

RFE-FRHF+WSR/WJR 250 V

Part number	No. of conductors x Conductor area (mm ²)	Nominal outer Ø (mm)	Weight kg/km	Min. bending radius mm (fixed)
620520	1 x 2 x 0.75	9.5	110	55
620522	2 x 2 x 0.75 Quad	11.5	165	70
620524	2 x 2 x 0.75	14.5	200	85
620526	4 x 2 x 0.75	17.0	285	100
620528	7 x 2 x 0.75	20.5	465	125
620530	8 x 2 x 0.75	22.0	520	130
620532	10 x 2 x 0.75	25.5	645	150
620534	12 x 2 x 0.75	26.5	720	160
620536	14 x 2 x 0.75	28.0	800	170
620537	16 x 2 x 0.75	30.0	900	180
620538	19 x 2 x 0.75	32.0	1020	195
620540	24 x 2 x 0.75	36.0	1270	215
620575	1 x 2 x 1.5	11.0	150	65
620577	2 x 2 x 1.5 Quad	12.5	215	75
620579	2 x 2 x 1.5	17.0	310	100
620581	4 x 2 x 1.5	19.5	440	115
620583	7 x 2 x 1.5	23.5	670	140
620585	8 x 2 x 1.5	25.0	740	150
620587	10 x 2 x 1.5	28.5	905	170
620589	12 x 2 x 1.5	30.0	1035	180
620591	14 x 2 x 1.5	32.0	1165	195
620593	16 x 2 x 1.5	34.5	1320	205
620595	19 x 2 x 1.5	37.0	1510	220

Standard length 1000 m

SHF2 on request. Part number for SHF2 cables 4 + code from above table → 4xxxxx

Other sizes on request.

RFE-FRHF (i)+WSR/WJR

250 V

Fire-resistant + Water Spray Resistant and/or Water Jet Resistant
armoured individually screened pair instrumentation
and communication cable

250 V CABLES

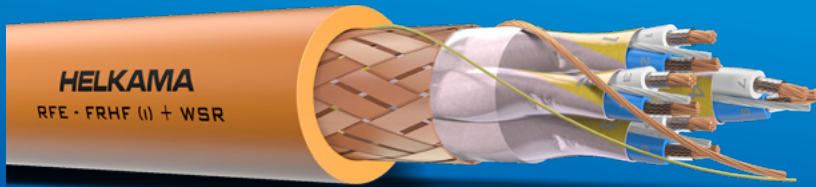

• Flame-retardant • Fire-resistant • Halogen-free • Low smoke emission • Water Spray and/or Water Jet Resistant

CONDUCTOR	Stranded copper conductor, IEC 60228 Class 2
INSULATION	Special grade Mica tape XLPE
TWISTED PAIR & INDIVIDUAL SCREEN	Two insulated cores twisted together to form a pair Aluminium polyester tape and tinned copper drain wire
CABLING/BEDDING	Cabling, pairs twisted together, with optional fillers to obtain symmetrical and round construction. Bedding, lapped tape.
ARMOUR	Copper drain wire (all sizes) Copper wire braid, coverage > 90% Tinned copper wire braid on request Armour serves as collective screen
SHEATH	Polyolefine SHF1, IEC 60092-360 Thermosetting polyolefine SHF2 on request Standard colour orange, SHF2 standard colour black, other colours on request
REFERENCE STANDARD	IEC 60092-376

APPLICATION

Fire-resistant + Water Spray Resistant and/or Water Jet Resistant armoured and individually screened pair instrumentation and communication cable. For fixed installation in most areas, and on open deck in ships and offshore units. Especially intended to ensure availability of all critical transportation-, comfort- and safety systems, i.e. to meet the concepts of; **Orderly Evacuation** (3 hours burning time) and **Safe Return to Port** (Fire test with simultaneous Water Spray / Water Jet + mechanical shocks) to simulate firefighting conditions.
If the cable is exposed to direct sunlight, protective covering or cable with black outer sheath is recommended.

PHYSICAL PROPERTIES:

CABLE TYPES	Cable Ø ≤20 mm RFE-FRHF (i)+WSR Cable Ø >20 mm RFE-FRHF (i)+WJR
CORE IDENTIFICATION	Pair colours white and blue Pair identification with colour code and identification number
MARINE TYPE APPROVALS	DNV, LR, RINA

MAIN CHARACTERISTICS:

RATED VOLTAGE	150/250 V (300 V)
FIRE PERFORMANCE	IEC 60332-1-2 IEC 60332-3-22
HALOGEN-FREE	IEC 60754 series
FIRE- AND WATER SPRAY RESISTANT (WSR)	IEC 60331-2 + EN 50200 Annex E (180 min)
FIRE- AND WATER JET RESISTANT (WJR)	IEC 60331-1 + BS 8491 (180 min)
SMOKE EMISSION	IEC 61034 series
OIL RESISTANCE (SHF2 only)	IEC 60811-404 conditions according to 60092-360/SHF2
MIN. INSTALLATION TEMPERATURE	-15 °C
OPERATING TEMPERATURE	-40 - 80 °C fixed installation
MAXIMUM CONDUCTOR TEMPERATURE	90 °C

ELECTRICAL PROPERTIES:

	0.75 mm ²	1.5 mm ²	Unit
Loop resistance (pair, max 20 °C)	52	24.4	ohm/km
Pair capacitance (nom. 1 KHz)	55	75	nF/km
Loop inductance (nom.)	0.6	0.7	mH/km
Insulation resistance (20 °C)	≥ 1500	≥ 1500	Mohm/km

RFE-FRHF (i)+WSR/WJR 250 V

Part number	No. of conductors x Conductor area (mm ²)	Nominal outer Ø (mm)	Weight kg/km	Min. bending radius mm (fixed)
620546	1 x 2 x 0.75	9.5	115	55
620548	2 x 2 x 0.75 Quad	11.0	165	65
620550	2 x 2 x 0.75	14.5	220	85
620552	4 x 2 x 0.75	17.0	345	105
620554	7 x 2 x 0.75	20.5	505	125
620556	8 x 2 x 0.75	22.0	555	130
620558	10 x 2 x 0.75	25.0	690	150
620560	12 x 2 x 0.75	26.5	785	160
620562	14 x 2 x 0.75	28.0	880	170
620536	16 x 2 x 0.75	30.0	990	180
620564	19 x 2 x 0.75	32.0	1125	190
620566	24 x 2 x 0.75	36.0	1400	215
620603	1 x 2 x 1.5 mm ²	10.5	155	65
620604	2 x 2 x 1.5 mm ² Quad	12.0	220	75
620605	2 x 2 x 1.5 mm ²	16.5	345	100
620607	4 x 2 x 1.5 mm ²	19.0	470	115
620609	7 x 2 x 1.5 mm ²	23.0	710	140
620611	8 x 2 x 1.5 mm ²	25.0	800	150
620513	10 x 2 x 1.5 mm ²	28.5	975	170
620615	12 x 2 x 1.5 mm ²	30.0	1135	180
620617	14 x 2 x 1.5 mm ²	32.0	1280	190
620619	16 x 2 x 1.5 mm ²	34.0	1440	205
620621	19 x 2 x 1.5 mm ²	36.5	1650	220

Standard length 1000 m

SHF2 on request. Part number for SHF2 cables 4 + code from above table → 4xxxxx

Other sizes on request.

RFA-FRHF+WSR/WJR

250 V

Fire-resistant + Water Spray Resistant and/or Water Jet Resistant screened pair instrumentation and communication cable

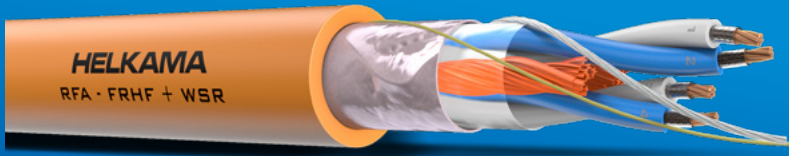

• Flame-retardant • Fire-resistant • Halogen-free • Low smoke emission • Water Spray and/or Water Jet Resistant

CONDUCTOR	Stranded copper conductor, IEC 60228 Class 2
INSULATION	Special grade Mica tape XLPE
TWISTED PAIR	Two insulated cores twisted together to form a pair Aluminium polyester tape and finned copper drain wire
CABLING	Pairs twisted together, with optional fillers to obtain symmetrical and round construction, covered by separator tape.
COLLECTIVE SCREEN	Tinned copper drain wire (all sizes) Aluminium polyester tape, coverage 100%
SHEATH	Polyolefine SHF1, IEC 60092-360 Thermosetting polyolefine SHF2 on request Standard colour orange, SHF2 standard colour black, other colours on request
REFERENCE STANDARD	IEC 60092-376

APPLICATION

Fire-resistant + Water Spray Resistant and/or Water Jet Resistant screened pair instrumentation and communication cable. For fixed installation in most areas, and on open deck in ships and offshore units. Especially intended to ensure availability of all critical transportation-, comfort- and safety systems, i.e. to meet the concepts of; **Orderly Evacuation** (3 hours burning time) and **Safe Return to Port** (Fire test with simultaneous Water Spray / Water Jet + mechanical shocks) to simulate firefighting conditions.

If the cable is exposed to direct sunlight, protective covering or cable with black outer sheath is recommended.

PHYSICAL PROPERTIES:

CABLE TYPES	Cable Ø ≤20 mm RFA-FRHF+WSR Cable Ø >20 mm RFA-FRHF+WJR
CORE IDENTIFICATION	Pair colours white and blue Pair identification with colour code and identification number
MARINE TYPE APPROVALS	DNV, LR, RINA

MAIN CHARACTERISTICS:

RATED VOLTAGE	150/250 V (300 V)
FIRE PERFORMANCE	IEC 60332-1-2 IEC 60332-3-22
HALOGEN-FREE	IEC 60754 series
SMOKE EMISSION	IEC 61034 series
FIRE- AND WATER SPRAY RESISTANT	IEC 60331-2 + EN 50200 Annex E (180 min)
FIRE- AND WATER JET RESISTANT	IEC 60331-1 + BS 8491 (180 min)
OIL RESISTANCE (SHF2 only)	IEC 60811-404 conditions according to 60092-360/SHF2
MIN. INSTALLATION TEMPERATURE	-15 °C
OPERATING TEMPERATURE	-40 - 80 °C fixed installation
MAXIMUM CONDUCTOR TEMPERATURE	90 °C

ELECTRICAL PROPERTIES:

	0.75 mm ²	1.5 mm ²	Unit
Loop resistance (pair, max 20 °C)	52	24.4	ohm/km
Pair capacitance (nom. 1 KHz)	45	55	nF/km
Loop inductance (nom.)	0.6	0.7	mH/km
Insulation resistance (20 °C)	≥ 1500	≥ 1500	Mohm/km

RFA-FRHF+WSR/WJR 250 V

Part number	No. of conductors x Conductor area (mm ²)	Nominal outer Ø (mm)	Weight kg/km	Min. bending radius mm (fixed)
620635	1 x 2 x 0.75	8.5	75	70
620637	2 x 2 x 0.75 Quad	10.0	110	80
620639	2 x 2 x 0.75	13.5	160	110
620641	4 x 2 x 0.75	16.0	220	130
620643	7 x 2 x 0.75	19.5	335	155
620645	8 x 2 x 0.75	20.5	375	165
620647	10 x 2 x 0.75	23.5	465	190
620649	12 x 2 x 0.75	25.0	530	200
620651	14 x 2 x 0.75	27.0	625	215
620653	16 x 2 x 0.75	28.5	695	230
620655	19 x 2 x 0.75	31.0	815	250
620657	24 x 2 x 0.75	34.5	1005	275
621521	1 x 2 x 1.5	9.5	105	75
621524	2 x 2 x 1.5 Quad	11.5	170	95
621525	2 x 2 x 1.5	15.5	225	125
621527	4 x 2 x 1.5	18.0	325	145
621529	7 x 2 x 1.5	22.0	510	175
621531	8 x 2 x 1.5	24.0	595	190
621533	10 x 2 x 1.5	27.5	735	220
621535	12 x 2 x 1.5	29.0	845	230
621537	14 x 2 x 1.5	31.0	975	250
621539	16 x 2 x 1.5	33.0	1090	265
621541	19 x 2 x 1.5	36.0	1295	285

Standard length 1000 m

SHF2 on request. Part number for SHF2 cables 4 + code from above table → 4xxxxx

Other sizes on request.

RFA-FRHF (i)+WSR/WJR

250 V

Fire-resistant + Water Spray Resistant and/or Water Jet Resistant collectively and individually screened pair instrumentation and communication cable

250 V CABLES

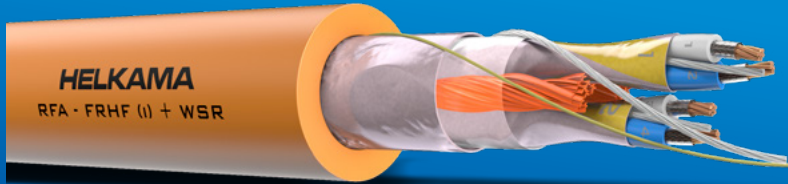

- Flame-retardant • Fire-resistant • Halogen-free • Low smoke emission • Water Spray and/or Water Jet Resistant

CONDUCTOR	Stranded copper conductor, IEC 60228 Class 2
INSULATION	Special grade Mica tape XLPE
TWISTED PAIR TWISTED PAIR & INDIVIDUAL SCREEN	Two insulated cores twisted together to form a pair
CABLING	Pairs twisted together, with optional fillers to obtain symmetrical and round construction, covered by separator tape.
COLLECTIVE SCREEN	Tinned copper drain wire (all sizes) Aluminium polyester tape, coverage 100%
SHEATH	Polyolefine SHF1, IEC 60092-360 Thermosetting polyolefine SHF2 on request Standard colour orange, SHF2 standard colour black, other colours on request
REFERENCE STANDARD	IEC 60092-376

APPLICATION

Fire-resistant + Water Spray Resistant and/or Water Jet Resistant collectively and individually screened pair instrumentation and communication cable. For fixed installation in most areas, and on open deck in ships and offshore units. Especially intended to ensure availability of all critical transportation-, comfort- and safety systems, i.e. to meet the concepts of; **Orderly Evacuation** (3 hours burning time) and **Safe Return to Port** (Fire test with simultaneous Water Spray / Water Jet + mechanical shocks) to simulate firefighting conditions.

If the cable is exposed to direct sunlight, protective covering or cable with black outer sheath is recommended.

PHYSICAL PROPERTIES:

CABLE TYPES	Cable Ø ≤20 mm RFA-FRHF (i) +WSR Cable Ø >20 mm RFA-FRHF (i) +WJR
CORE IDENTIFICATION	Pair colours white and blue Pair identification with colour code and identification number
MARINE TYPE APPROVALS	DNV, LR, RINA

MAIN CHARACTERISTICS:

RATED VOLTAGE	150/250 V (300 V)
FIRE PERFORMANCE	IEC 60332-1-2 IEC 60332-3-22
HALOGEN-FREE	IEC 60754 series
SMOKE EMISSION	IEC 61034 series
FIRE- AND WATER SPRAY RESISTANT (WSR)	IEC 60331-2 + EN 50200 Annex E (180 min)
FIRE- AND WATER JET RESISTANT (WJR)	IEC 60331-1 + BS 8491 (180 min)
OIL RESISTANCE (SHF2 only)	IEC 60811-404 conditions according to 60092-360/SHF2
MIN. INSTALLATION TEMPERATURE	-15 °C
OPERATING TEMPERATURE	-40 - 80 °C fixed installation
MAXIMUM CONDUCTOR TEMPERATURE	90 °C

ELECTRICAL PROPERTIES:

	0.75 mm ²	1.5 mm ²	Unit
Loop resistance (pair, max 20 °C)	52	24.4	ohm/km
Pair capacitance (nom. 1 KHz)	55	75	nF/km
Loop inductance (nom.)	0.6	0.7	mH/km
Insulation resistance (20 °C)	≥ 1500	≥ 1500	Mohm/km

RFA-FRHF (i)+WSR/WJR 250 V

Part number	No. of conductors x Conductor area (mm ²)	Nominal outer Ø (mm)	Weight kg/km	Min. bending radius mm (fixed)
620664	1 x 2 x 0.75	9.0	80	70
620666	2 x 2 x 0.75 Quad	16.0	165	125
620667	2 x 2 x 0.75	13.5	175	110
620669	4 x 2 x 0.75	16.0	245	130
620671	7 x 2 x 0.75	19.5	380	155
620673	8 x 2 x 0.75	21.0	435	170
620675	10 x 2 x 0.75	24.5	555	195
620677	12 x 2 x 0.75	25.5	630	205
620679	14 x 2 x 0.75	27.5	715	220
620681	16 x 2 x 0.75	29.0	815	235
620683	19 x 2 x 0.75	31.5	940	250
620685	24 x 2 x 0.75	35.5	1195	285
621550	1 x 2 x 1.5	10.0	110	80
621552	2 x 2 x 1.5 Quad	18.0	245	145
621553	2 x 2 x 1.5	15.5	245	125
621555	4 x 2 x 1.5	18.5	365	145
621557	7 x 2 x 1.5	22.5	575	180
621559	8 x 2 x 1.5	24.5	665	195
621561	10 x 2 x 1.5	28.0	840	225
621563	12 x 2 x 1.5	29.5	965	235
621565	14 x 2 x 1.5	31.5	1100	250
621567	16 x 2 x 1.5	33.5	1265	270
621569	19 x 2 x 1.5	36.5	1485	290

Standard length 1000 m

SHF2 on request. Part number for SHF2 cables 4 + code from above table → 4xxxxx

Other sizes on request.

FXMSU

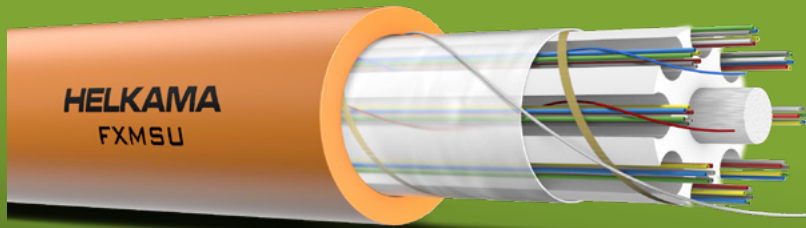

		Max 30 fibers	Max 48 fibers	Unit
CENTRAL ELEMENT, GLASS FIBER		1.5	3.3	Ø mm
PP-SLOTTED CORE		6.0	9.5	Ø mm
OPTICAL FIBERS		250	250	Ø µm
WRAPPING	Aramid binding yarn			
WATER BLOCKING	Water swellable tape			
SHEATH	LSZH Thermoplastic Standard colour orange			
REFERENCE STANDARD	Helkama specification			

APPLICATION

Optical fiber cable for indoor/outdoor application.

PHYSICAL PROPERTIES:

	Max 30 fibers	Max 48 fibers	Unit	Mechanical test
TENSILE STRENGTH	500	1750	N	EN 187000 method 501
CRUSH STRENGTH/ 100 mm (PLATE)	4000	4000	N	EN 187000 method 504
CRUSH STRENGTH/ 25 mm (MANDREL)	650	1000	N	EN 187000 method 504
IMPACT STRENGTH	25	50	J	EN 187000 method 505
LONGITUDINAL WATER TIGHTNESS				EN 18700 method 605B
MIN. BENDING RADIUS (installation/fixed)	15/10 x Ø 15/10 x Ø			
NOMINAL OUTER Ø	9.4	13.1	mm	
CABLE WEIGHT	75	146	kg/km	
MARINE TYPE APPROVALS	BV, DNV, RINA			

MAIN CHARACTERISTICS:

FIRE PERFORMANCE	Eca IEC 60332-1-2 IEC 60332-3-22
UV RESISTANCE	UL1581 section 1200
HALOGEN-FREE	IEC 60754-1
ACIDITY OF COMBUSTION GASES	IEC 60754-2
CONDUCTIVITY OF COMBUSTION GASES	IEC 60754-2
SMOKE EMISSION	IEC 61034 series
MIN. INSTALLATION TEMPERATURE	-15 °C
OPERATING TEMPERATURE	-45 - 70 °C

FXMSU

Part number	Cable type
10001	FXMSU 1 x 4 SML (L)
10022	FXMSU 1 x 6 SML (L)
10003	FXMSU 2 x 4 SML (L)
10024	FXMSU 2 x 6 SML (L)
10028	FXMSU 4 x 6 SML (L)
14404	FXMSU 1 x 4 GKL (L)
14408	FXMSU 2 x 4 GKL (L)
14410	FXMSU 3 x 4 GKL (L)
14416	FXMSU 4 x 6 GKL (L)
14420	FXMSU 1 x 4 SML + 1 x 4 GKL (L)
14422	FXMSU 1 x 4 SML + 2 x 4 GKL (L)
14424	FXMSU 2 x 4 SML + 2 x 4 GKL (L)
14426	FXMSU 1 x 6 SML + 3 x 4 GKL (L)
14428	FXMSU 2 x 6 SML + 3 x 4 GKL (L)
14384	FXMSU 1 x 4 OM3L (L)
14386	FXMSU 2 x 4 OM3L (L)
14388	FXMSU 3 x 4 OM3L (L)
14398	FXMSU 4 x 6 OM3L (L)
14450	FXMSU 1 x 4 SML + 2 x 4 OM3L (L)
14451	FXMSU 2 x 4 SML + 2 x 4 OM3L (L)
14454	FXMSU 1 x 6 SML + 3 x 4 OM3L (L)
14455	FXMSU 2 x 6 SML + 3 x 4 OM3L (L)
14601	FXMSU 1 x 4 OM4L (L)
14542	FXMSU 2 x 4 OM4L (L)
14543	FXMSU 3 x 4 OM4L (L)
14614	FXMSU 4 x 6 OM4L (L)
14470	FXMSU 1 x 4 SML + 2 x 4 OM4L (L)
14472	FXMSU 2 x 4 SML + 2 x 4 OM4L (L)
14474	FXMSU 1 x 6 SML + 3 x 4 OM4L (L)
14620	FXMSU 2 x 6 SML + 3 x 4 OM4L (L)
14478	FXMSU 4 x 6 SML + 4 x 6 OM4L
10016	FXMSU 8 x 6 SML
14219	FXMSU 8 x 6 GKL
14244	FXMSU 4 x 6 SML + 4 x 6 GKL
14256	FXMSU 8 x 6 OM3L
14264	FXMSU 4 x 6 SML + 4 x 6 OM3L
14568	FXMSU 8 x 6 OM4L

Other types on request

FXMMS

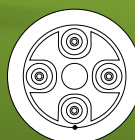
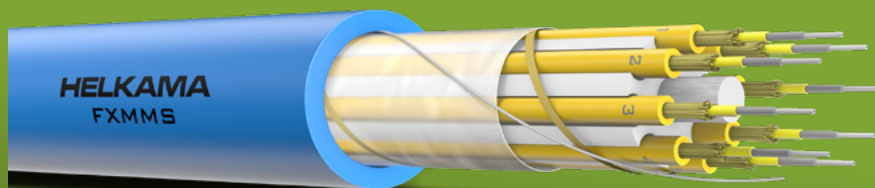

	Max 4 fibers	Max 8 fibers	Unit
CENTRAL ELEMENT, GLASS FIBER	2.0	2.0	Ø mm
PP-SLOTTED CORE	7.5	9.7	Ø mm
INSTALLATION CABLE UNIT	FMS 1 (2 mm) Yellow colour (SMT fibers) Green colour (GKT, OM3T and OM4T fibers)		
WRAPPING	Aramid binding yarn Fire barrier tape Rip cord under sheath		
SHEATH	LSZH Thermoplastic Standard colour blue (SMT fibers) Standard colour green (GKT, OM3T and OM4T fibers)		
REFERENCE STANDARD	Helkama specification		

APPLICATION

Halogen-free optical fiber installation cable for indoor application.

PHYSICAL PROPERTIES:

	Max 4 fibers	Max 8 fibers	Unit	Mechanical test
TENSILE STRENGTH	1500	1750	N	EN 187000 method 501
CRUSH STRENGTH/ 100 mm (PLATE)	4000	7000	N	EN 187000 method 504
CRUSH STRENGTH/ 25 mm (MANDREL)	750	1000	N	EN 187000 method 504
IMPACT STRENGTH	30	30	J	EN 187000 method 505
MIN. BENDING RADIUS (installation/fixed)	15/10 x Ø	15/10 x Ø	mm	
NOMINAL OUTER Ø	10.7	13.1	mm	
CABLE WEIGHT	102	142	kg/km	
MARINE TYPE APPROVALS	BV, DNV, LR, RINA			

MAIN CHARACTERISTICS:

FIRE PERFORMANCE	Eca IEC 60332-1 IEC 60332-3-22
HALOGEN-FREE	IEC 60754-1
ACIDITY OF COMBUSTION GASES	IEC 60754-2
CONDUCTIVITY OF COMBUSTION GASES	IEC 60754-2
SMOKE EMISSION	IEC 61034 series
MIN. INSTALLATION TEMPERATURE	-15 °C
OPERATING TEMPERATURE	-45 - 70 °C

FXMMS

Part number	Cable type
10810	FXMMS 2 SMT (2 mm)
10812	FXMMS 4 SMT (2 mm)
10814	FXMMS 6 SMT (2 mm)
10816	FXMMS 8 SMT (2 mm)
13747	FXMMS 2 GKT (2 mm)
13748	FXMMS 4 GKT (2 mm)
13749	FXMMS 6 GKT (2 mm)
13750	FXMMS 8 GKT (2 mm)
13872	FXMMS 2 OM3T (2 mm)
13874	FXMMS 4 OM3T (2 mm)
13876	FXMMS 6 OM3T (2 mm)
13878	FXMMS 8 OM3T (2 mm)
13910	FXMMS 2 OM4T (2 mm)
13912	FXMMS 4 OM4T (2 mm)
13914	FXMMS 6 OM4T (2 mm)
13916	FXMMS 8 OM4T (2 mm)

Other types on request



Shutterstock

FXVDMSU

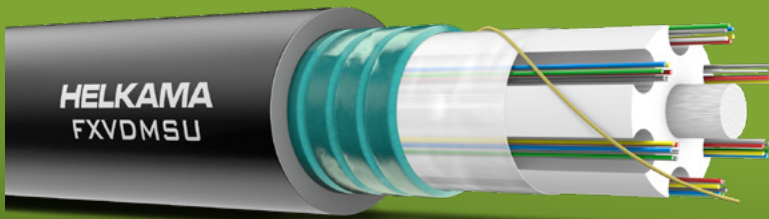

	Max 36 fibers	Max 48 fibers	Unit
CENTRAL ELEMENT, GLASS FIBER	3.3	3.3	Ø mm
PP-SLOTTED CORE	8.5	9.5	Ø mm
OPTICAL FIBERS	250	250	Ø µm
WRAPPING	Aramid binding yarn		
WATER BLOCKING	Corrugated steel tape		
SHEATH	UV-protected and Halogen-free polyolefin plastic Standard colour black Other colours on request		

APPLICATION

Optical fiber cable for indoor/outdoor application and installation in marine, offshore and industrial use.

PHYSICAL PROPERTIES:

	Max 36 fibers	Max 48 fibers	Unit	Mechanical test
TENSILE STRENGTH	2500	2500	N	IEC 60794-1-2 E1
CRUSH STRENGTH/ 100 mm (PLATE)	7000	7000	N	IEC 60794-1-2 E3
CRUSH STRENGTH/ 25 mm (MANDREL)	1500	1500	N	IEC 60794-1-2 E3
IMPACT STRENGTH	50	50	J	IEC 60794-1-2 E4
MIN. BENDING RADIUS (installation/fixed)	270/200	300/230	mm	
NOMINAL OUTER Ø	13.5	15.0	mm	
CABLE WEIGHT	180	210	kg/km	
MARINE TYPE APPROVALS	BV, DNV, RINA			

MAIN CHARACTERISTICS:

FLAME-RETARDANT	IEC 60332-1-2 IEC 60332-3-22
HALOGEN-FREE	IEC 60754-1
LIGHT TRANSMISSION	> 60%, IEC 61034-1;2
MIN. INSTALLATION TEMPERATURE	-15 °C
OPERATING TEMPERATURE	-30 - 70 °C

Subject to change without prior notice. See latest update on our webpage.

© 2022 Helkama Bica Oy. All rights reserved.

FXVDMSU

Part number	Cable type
14705	FXVDMSU 1X6 SML
14704	FXVDMSU 2X6 SML
14710	FXVDMSU 4X6SML
14730	FXVDMSU 8X6SML
14735	FXVDMSU 1X6SML+7x60M2L
14752	FXVDMSU 2X6SML+3X40M3L
14754	FXVDMSU 2X6SML+3X40M4L
14756	FXVDMSU 2X6SML+4X60M4L
14744	FXVDMSU 7X6SML+1x60M2L
14706	FXVDMSU 1X6 OM3L
14733	FXVDMSU 4X4 OM3L
14734	FXVDMSU 4X6 OM3L
14707	FXVDMSU 3X4 OM4L
14708	FXVDMSU 6X4 OM4L

Other types on request

LIFECORD-FRHF (f)

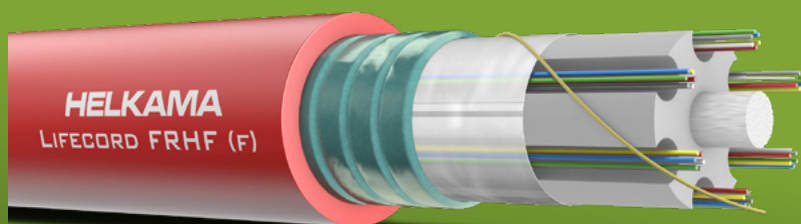

CENTRAL ELEMENT	Glass fiber, Ø 3.3 mm
PP-SLOTTED CORE	Ø 8.0 mm
OPTICAL FIBERS	Ø 250 μm
WATER BLOCKING	Water swellable tape Corrugated steel tape
SHEATH	LSZH Thermoplastic Standard colour red
REFERENCE STANDARD	Helkama specification

APPLICATION

Fire-resistant optical fiber cable for indoor application. For fixed installation where the cable has to maintain its functionality during fire.

PHYSICAL PROPERTIES:

		Unit	Mechanical test
MAX PULLING FORCE	2500	N	IEC 60794-1-2 E1
CRUSH STRENGTH/ 100 mm (PLATE)	7000	N	IEC 60794-1-2 E3
CRUSH STRENGTH/ 25 mm (MANDREL)	1500	N	IEC 60794-1-2 E3
IMPACT STRENGTH	50	J	IEC 60794-1-2 E4
MIN. BENDING RADIUS (installation/fixed)	270/200	mm	
NOMINAL OUTER Ø	13.5	mm	
CABLE WEIGHT	196	kg/km	
MARINE TYPE APPROVALS	BV, DNV, RINA		

MAIN CHARACTERISTICS:

FIRE PERFORMANCE	IEC 60332-1-2 IEC 60332-3-22
FIRE-RESISTANT	IEC 60331-25 (180 min)
HALOGEN-FREE	IEC 60754 series
SMOKE EMISSION	IEC 61034 series
MIN. INSTALLATION TEMPERATURE	-15 °C
OPERATING TEMPERATURE	-30 - 70 °C

Subject to change without prior notice. See latest update on our webpage.

© 2022 Helkama Bica Oy. All rights reserved.

LIFECORD-FRHF (f)

Part number	Cable type
15001	LifeCord FRHF 1 x 4 GKL
15005	LifeCord FRHF 1 x 4 SML
15006	LifeCord FRHF 1 x 6 SML
15008	LifeCord FRHF 2 x 6 SML
15012	LifeCord FRHF 4 x 6 SML
15020	LifeCord FRHF 1 x 4 SML + 2 x 4 GKL
15039	LifeCord FRHF 1 x 4 SML + 1 x 4 OM3L
15041	LifeCord FRHF 1 x 6 SML + 3 x 4 GKL
15043	LifeCord FRHF 2 x 6 SML + 3 x 4 GKL
15045	LifeCord FRHF 2 x 6 SML + 3 x 4 OM3L
15048	LifeCord FRHF 3 x 6 SML + 3 x 6 GKL
15062	LifeCord FRHF 2 x 4 GKL
15063	LifeCord FRHF 3 x 4 GKL
15066	LifeCord FRHF 6 x 4 GKL
15071	LifeCord FRHF 1 x 4 OM3L
15073	LifeCord FRHF 2 x 4 OM3L
15075	LifeCord FRHF 3 x 4 OM3L
15081	LifeCord FRHF 6 x 4 OM3L
15095	LifeCord FRHF 3 x 4 OM4L

Other types on request

OPTICAL FIBER CABLE CHARACTERISTICS

SINGLE-MODE FIBER

Conditions		SM/OS2	Unit
Standards according to ITU-T		G.652.D	
Attenuation (max)	1310 nm	≤ 0.40	dB/km
	1550 nm	≤ 0.30	dB/km
Cut-off wavelength		≤ 1260	nm
Cut-off wavelength installation		1180 – 1250	nm
Zero dispersion wavelength		1300 – 1324	nm
Zero dispersion slope		≤ 0.092	ps/nm ² /km
Polarization mode dispersion		≤ 0.5	ps/√km
Mode field diameter (MFD)	1310 nm	9.1 ± 0.4	μm
	1550 nm	10.3 ± 0.4	μm
Mode field eccentricity		≤ 1.0	μm
Mode field eccentricity, installation		≤ 0.5	μm
Cladding diameter		125 ± 2	μm
Cladding diameter, installation		125 ± 1	μm
Cladding ellipticity		≤ 1	%



Shutterstock

Subject to change without prior notice. See latest update on our webpage.

© 2022 Helkama Bica Oy. All rights reserved.

MULTI MODE FIBER

Conditions					Unit
Fiber class		GK/OM1	OM3	OM4	
		GKL 250 ± 10	OM3L 250 ± 10	OM4L 250 ± 10	µm
Attenuation (max)		GKT 900 ± 50	OM3T 900 ± 50	OM4T 900 ± 50	µm
	850 nm	3.0	2.7	2.5	dB/km
	1300 nm	≤ 1.0	≤ 0.8	≤ 0.8	dB/km
Bandwidth	850 nm (LED)	≥ 200	≥ 1500	≥ 3500	MHz x km
	1300 nm (LED)	≥ 500	≥ 500	≥ 500	MHz x km
	850 nm (Laser)		≥ 2000	≥ 4700	MHz x km
Numerical aperture (NA)		0.275 ± 0.015	0.200 ± 0.015	0.200 ± 0.015	
Core diameter		62.5 ± 3	50 ± 2	50 ± 2.5	µm
Core ellipticity		≤ 6	≤ 6	≤ 6	%
Core eccentricity		≤ 3	≤ 3	≤ 2	µm
Cladding diameter		125 ± 2	125 ± 1	125 ± 1	µm
Cladding ellipticity		≤ 2	≤ 2	≤ 2	%



Fiber colouring

Colour codes:

6 colour system according to SFS 5648

Fibers

1*)	Blue	
2	White	
3	Yellow	
4	Green	
5	Grey	
6**)	Red	

Identification threads:

First and last slot marked with an identification thread

Slot

First	Blue	
Last	Red	

*) Colour of first fiber in slot

***) Colour of last fiber in slot

Examples of fiber colours:

- Two fibers in one slot: 1st fiber blue, 2nd= last fiber red
- Four fibers in one slot: 1st fiber blue, 2nd fiber white, 3rd fiber yellow, 4th= last fiber red



Photo credit/copyright: Helkama Bica Oy

© 2022 Helkama Bica Oy. All rights reserved.

Subject to change without prior notice. See latest update on our webpage.

helkamabica.com
customer.care@helkamabica.fi
+358 2 410 8700

HELKAMA
THE PERFECT CONNECTION

CAT 7

S/FTP 4 PR AWG 23/1



CONDUCTOR	Solid copper conductor 23 AWG/1
INSULATION	Foam PE
PAIR SHIELDING	Aluminium foil
SHIELDING	Tinned copper wire braid
SHEATH	LSZH
REFERENCE STANDARD	IEC 61156-5 & ISO/IEC 11801

PHYSICAL PROPERTIES:

BENDING RADIUS (Installation)	8 x Ø
MAX. RECOMMENDED PULLING TENSION	80 N
NOMINAL OUTER Ø	7.7 ± 0.3 mm
CABLE WEIGHT	66 kg/km
CORE IDENTIFICATION	
Pair colours	1. White/Blue stripe & Blue 2. White/Orange stripe & Orange 3. White/Green stripe & Green 4. White/Brown stripe & Brown
PACKAGING	500 m drum, 1000 m drum
MARINE TYPE	
APPROVALS	DNV, LR, RINA

MAIN CHARACTERISTICS:

FIRE PERFORMANCE	Dca-s1a, d2, a1 IEC 60332-1-2 IEC 60332-3-22
MAX. CONDUCTOR DC RESISTANCE	95 Ω/km @20 °C
CONDUCTOR LOOP RESISTANCE	max. 19 Ω/100 m @20 °C
NOM. MUTUAL CAPACITANCE	≤ 5.6 nF/100 m @1 kHz
CAPACITANCE UNBALANCE PAIR TO GROUND	≤ 1600 pF/km @1 kHz
MIN. INSULATION RESISTANCE	5000 MΩ/m
IMPEDANCE	100 ± 25 Ω @100 MHz
RATED TEMPERATURE	75 °C
OPERATING TEMPERATURE RANGE	-20 °C - 75 °C

Subject to change without prior notice. See latest update on our webpage.

© 2022 Helkama Bica Oy. All rights reserved.

Part number	Cable type	Colour	Standard length m
3340124042	CAT 7 S/FTP AWG 23/1	Black	500
3340224042	CAT 7 S/FTP AWG 23/1	Yellow	500
3340324042	CAT 7 S/FTP AWG 23/1	Grey	500
3340424042	CAT 7 S/FTP AWG 23/1	White	500
3340524042	CAT 7 S/FTP AWG 23/1	Orange	500
3340624042	CAT 7 S/FTP AWG 23/1	Blue	500
3340724042	CAT 7 S/FTP AWG 23/1	Red	500
3340824042	CAT 7 S/FTP AWG 23/1	Green	500
3341124042	CAT 7 S/FTP AWG 23/1	Black	1000
3341224042	CAT 7 S/FTP AWG 23/1	Yellow	1000
3341324042	CAT 7 S/FTP AWG 23/1	Grey	1000
3341424042	CAT 7 S/FTP AWG 23/1	White	1000
3341524042	CAT 7 S/FTP AWG 23/1	Orange	1000
3341624042	CAT 7 S/FTP AWG 23/1	Blue	1000
3341724042	CAT 7 S/FTP AWG 23/1	Red	1000
3341824042	CAT 7 S/FTP AWG 23/1	Green	1000

PERFORMANCE:

F (MHz)	ATT (dB/100 m)	RL (dB)	NEXT (dB)	PS NEXT (dB)	ACRF (EL FEXT) (dB/100 m)	PS ACRF (PS EL FEXT) (dB/100 m)	PD (ns/100 m)
4.0	3.6	30	98	95	96	92	449
8.0	5.0	32	98	95	94	89	444
10.0	5.6	35	98	95	91	90	442
16.0	7.2	35	98	95	81	76	440
20.0	8.1	38	99	96	81	77	439
25.0	9.1	39	98	95	84	76	438
31.2	10.0	39	97	94	83	77	437
62.5	14.5	34	95	92	79	76	436
100.0	17.7	32	92	89	82	73	435
200.0	26.1	30	88	85	69	66	434
250.0	27.9	28	86	83	74	65	434
300.0	31.9	27	86	83	69	64	433
400.0	37.8	28	83	80	59	56	433
500.0	40.7	23	81	78	56	51	433
600.0	45.8	25	80	77	58	52	433

F = Frequency

ATT = Attenuation

RL = Return Loss

NEXT = Near End Crosstalk

PS NEXT = Power Sum Near End Crosstalk

ACRF (EL FEXT) = Attenuation to Crosstalk Ratio Far End Crosstalk

PS ACRF (PS EL FEXT) = Power Sum Attenuation to Crosstalk Ratio Far End Crosstalk

PD = Phase Delay

CAT 7

S/FTP 4 PR AWG 26/7



CONDUCTOR	Stranded tinned copper conductor 26 AWG/7
INSULATION	Foam PE
PAIR SHIELDING	Aluminium foil
SHIELDING	Tinned copper wire braid
SHEATH	LSZH
REFERENCE STANDARD	IEC 61156-6 & ISO/IEC 11801

PHYSICAL PROPERTIES:

BENDING RADIUS (Installation)	8 x Ø
MAX. RECOMMENDED PULLING TENSION	80 N
NOMINAL OUTER Ø	6.4 ± 0.3 mm
CABLE WEIGHT	39 kg/km
CORE IDENTIFICATION Pair colours	1. White/Blue stripe & Blue 2. White/Orange stripe & Orange 3. White/Green stripe & Green 4. White/Brown stripe & Brown
PACKAGING	500 m drum, 1000 m drum
MARINE TYPE APPROVALS	DNV, LR, RINA

MAIN CHARACTERISTICS:

FIRE PERFORMANCE	IEC 60332-1 IEC 60332-3-22
HALOGEN-FREE	IEC 60754 series
SMOKE EMISSION	IEC 61034 series
MAX. CONDUCTOR DC RESISTANCE	145 Ω/km @20 °C
CONDUCTOR LOOP RESISTANCE	max. 29 Ω/100 m @20 °C
NOM. MUTUAL CAPACITANCE	≤ 5.6 nF/100 m @1 kHz
CAPACITANCE UNBALANCE PAIR TO GROUND	≤ 1600 pF/km @1 kHz
MIN. INSULATION RESISTANCE	5000 MΩ/m
IMPEDANCE	100 ± 25 Ω @100 MHz
RATED TEMPERATURE	75 °C
OPERATING TEMPERATURE RANGE	-20 °C - 75 °C

Subject to change without prior notice. See latest update on our webpage.

© 2022 Helkama Bica Oy. All rights reserved.

ITEM NUMBERS:

Part number	Cable type	Colour	Standard length m
3360149042	CAT 7 S/FTP AWG 26/7	Black	500
3360249042	CAT 7 S/FTP AWG 26/7	Yellow	500
3360349042	CAT 7 S/FTP AWG 26/7	Grey	500
3360449042	CAT 7 S/FTP AWG 26/7	White	500
3360549042	CAT 7 S/FTP AWG 26/7	Orange	500
3360649042	CAT 7 S/FTP AWG 26/7	Blue	500
3360749042	CAT 7 S/FTP AWG 26/7	Red	500
3360849042	CAT 7 S/FTP AWG 26/7	Green	500
3361149042	CAT 7 S/FTP AWG 26/7	Black	1000
3361249042	CAT 7 S/FTP AWG 26/7	Yellow	1000
3361349042	CAT 7 S/FTP AWG 26/7	Grey	1000
3361449042	CAT 7 S/FTP AWG 26/7	White	1000
3361549042	CAT 7 S/FTP AWG 26/7	Orange	1000
3361649042	CAT 7 S/FTP AWG 26/7	Blue	1000
3361749042	CAT 7 S/FTP AWG 26/7	Red	1000
3361849042	CAT 7 S/FTP AWG 26/7	Green	1000

PERFORMANCE:

F (MHz)	ATT (dB/100 m)	RL (dB)	NEXT (dB)	PS NEXT (dB)	ACRF (EL FEXT) (dB/100 m)	PS ACRF (PS EL FEXT) (dB/100 m)	PD (ns/100 m)
4.0	4.9	32	107	95	117	-	463
8.0	6.8	32	107	98	107	-	457
10.0	7.6	35	105	96	100	-	456
16.0	9.6	34	104	95	116	-	453
20.0	10.8	43	117	98	106	-	452
25.0	12.2	40	115	100	103	-	451
31.2	13.7	39	107	100	108	-	450
62.5	19.7	42	114	102	113	-	447
100.0	25.1	39	102	100	109	-	446
200.0	35.9	37	111	104	102	-	445
250.0	40.1	33	104	99	112	-	444
300.0	44.3	33	114	101	109	-	444
600.0	63.9	27	102	93	106	-	443

If FEXT loss is greater than 70 dB, PS ACR-F loss may not be measured

F = Frequency

ATT = Attenuation

RL = Return Loss

NEXT = Near End Crosstalk

PS NEXT = Power Sum Near End Crosstalk

ACRF (EL FEXT) = Attenuation to Crosstalk Ratio Far End Crosstalk

PS ACRF (PS EL FEXT) = Power Sum Attenuation to Crosstalk Ratio Far End Crosstalk

PD = Phase Delay

CAT 7

S/FTP 4PR AWG 24/7

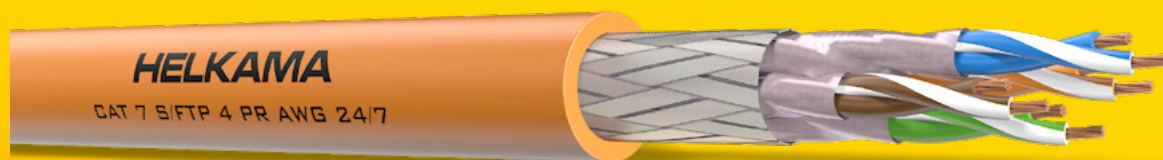

CONDUCTOR	Stranded copper conductor 24 AWG/7
INSULATION	Foam PE
PAIR SHIELDING	Aluminium foil
SHIELDING	Tinned copper wire braid
SHEATH	LSZH
REFERENCE STANDARD	IEC 61156-6 & ISO/IEC 11801

PHYSICAL PROPERTIES:

BENDING RADIUS (Installation)	8 x Ø
MAX. RECOMMENDED PULLING TENSION	80 N
NOMINAL OUTER Ø	7.6 ± 0.3 mm
CABLE WEIGHT	61 kg/km
CORE IDENTIFICATION Pair colours	1. White/Blue stripe & Blue 2. White/Orange stripe & Orange 3. White/Green stripe & Green 4. White/Brown stripe & Brown
PACKAGING	500 m drum, 1000 m drum
MARINE TYPE APPROVALS	DNV, LR, RINA

MAIN CHARACTERISTICS:

FIRE PERFORMANCE	IEC 60332-1 IEC 60332-3-22
HALOGEN-FREE	IEC 60754 series
SMOKE EMISSION	IEC 61034 series
MAX. CONDUCTOR DC RESISTANCE	148 Ω/km @20 °C
CONDUCTOR LOOP RESISTANCE	max. 29 Ω/100 m @20 °C
NOM. MUTUAL CAPACITANCE	≤ 5.6 nF/100 m @1 kHz
CAPACITANCE UNBALANCE PAIR TO GROUND	≤ 1600 pF/km @1 kHz
MIN. INSULATION RESISTANCE	5000 MΩ/m
IMPEDANCE	100 ± 25 Ω @100 MHz
RATED TEMPERATURE	80 °C
OPERATING TEMPERATURE RANGE	-20 °C - 75 °C

Subject to change without prior notice. See latest update on our webpage.

© 2022 Helkama Bica Oy. All rights reserved.

ITEM NUMBERS:

Part number	Cable type	Colour	Standard length m
3360124042	CAT 7 S/FTP AWG 24/7	Black	500
3360224042	CAT 7 S/FTP AWG 24/7	Yellow	500
3360324042	CAT 7 S/FTP AWG 24/7	Grey	500
3360424042	CAT 7 S/FTP AWG 24/7	White	500
3360524042	CAT 7 S/FTP AWG 24/7	Orange	500
3360624042	CAT 7 S/FTP AWG 24/7	Blue	500
3360724042	CAT 7 S/FTP AWG 24/7	Red	500
3360824042	CAT 7 S/FTP AWG 24/7	Green	500
3361124042	CAT 7 S/FTP AWG 24/7	Black	1000
3361224042	CAT 7 S/FTP AWG 24/7	Yellow	1000
3361324042	CAT 7 S/FTP AWG 24/7	Grey	1000
3361424042	CAT 7 S/FTP AWG 24/7	White	1000
3361524042	CAT 7 S/FTP AWG 24/7	Orange	1000
3361624042	CAT 7 S/FTP AWG 24/7	Blue	1000
3361724042	CAT 7 S/FTP AWG 24/7	Red	1000
3361824042	CAT 7 S/FTP AWG 24/7	Green	1000

PERFORMANCE:

F (MHz)	ATT (dB/100 m)	RL (dB)	NEXT (dB)	PS NEXT (dB)	ACRF (EL FEXT) (dB/100 m)	PS ACRF (PS EL FEXT) (dB/100 m)	PD (ns/100 m)
1.0	2.6	34	91	84	92	89	485
4.0	4.9	33	93	85	90	87	463
8.0	7.0	35	93	88	93	90	457
10.0	7.7	38	104	97	102	99	455
16.0	9.8	34	110	103	107	104	452
20.0	11.1	34	107	101	108	105	451
25.0	12.5	39	114	107	111	108	450
31.2	14.1	39	110	104	111	108	449
62.5	20.2	40	112	106	114	111	447
100.0	25.9	43	113	107	118	115	445
200.0	36.9	35	111	103	111	108	444
250.0	41.4	28	109	103	109	106	443
300.0	45.7	29	109	103	112	109	443
400.0	53.3	38	108	101	112	109	443
500.0	60.1	31	110	97	110	107	443
600.0	66.2	27	111	102	111	108	442

F = Frequency

ATT = Attenuation

RL = Return Loss

NEXT = Near End Crosstalk

PS NEXT = Power Sum Near End Crosstalk

ACRF (EL FEXT) = Attenuation to Crosstalk Ratio Far End Crosstalk

PS ACRF (PS EL FEXT) = Power Sum Attenuation to Crosstalk Ratio Far End Crosstalk

PD = Phase Delay

CAN-BUS

1 X 2 X 0.75 120 Ω



CONDUCTOR	Flexible tinned copper conductor 0.75 mm ²
INSULATION	PE
STRANDING	Two cores form a pair
SCREEN	Tinned copper wire braid Coverage 80%
OUTER SHEATH	LSZH
COLOUR	Violet

PHYSICAL PROPERTIES:

BENDING RADIUS	5 x Ø
NOMINAL OUTER Ø	8.7 ± 0.3 mm
CABLE WEIGHT	90 kg/km
CORE IDENTIFICATION	
Pair colours	1. White 2. Brown
PART NUMBER	29994
MARINE TYPE	
APPROVALS	DNV, LR, RINA

MAIN CHARACTERISTICS:

FIRE PERFORMANCE	IEC 60332-1-2 IEC 60332-3-22
OPERATING VOLTAGE	30 V
TEST VOLTAGE	1000 V
HALOGEN FREE	IEC 60754 series
SMOKE EMISSION	IEC 61034 series
CHARACTERISTIC IMPEDANCE	120 ± 12 Ω @1 MHz
OPERATING TEMPERATURE RANGE	-25 °C - 80 °C

Subject to change without prior notice. See latest update on our webpage.

© 2022 Helkama Bica Oy. All rights reserved.

CAN-BUS

2 X 2 X 0.75 120 Ω

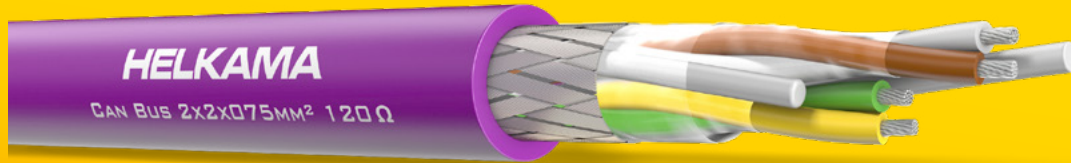

CONDUCTOR	Flexible tinned copper conductor 0.75 mm ²
INSULATION	PE
STRANDING	Two cores form a pair (two pairs) with fillers to obtain symmetrical and round construction
SCREEN	Tinned copper wire braid Coverage 80%
OUTER SHEATH	LSZH
COLOUR	Violet

PHYSICAL PROPERTIES:

BENDING RADIUS	5 x Ø
NOMINAL OUTER Ø	11.5 ± 0.3 mm
CABLE WEIGHT	154 kg/km
CORE IDENTIFICATION	
Pair colours	1. White 2. Brown 3. Yellow 4. Green
PART NUMBER	29995
MARINE TYPE APPROVALS	DNV, LR, RINA

MAIN CHARACTERISTICS:

FIRE PERFORMANCE	IEC 60332-1-2 IEC 60332-3-22
OPERATING VOLTAGE	30 V
TEST VOLTAGE	1000 V
HALOGEN FREE	IEC 60754 series
SMOKE EMISSION	IEC 61034 series
CHARACTERISTIC IMPEDANCE	120 ± 12 Ω @1 MHz
OPERATING TEMPERATURE RANGE	-25 °C - 80 °C

PROFIBUS DP

1 X 2 X AWG 22/7 -HF

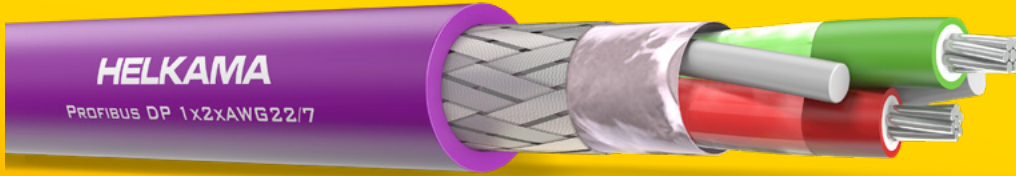

CONDUCTOR	Stranded tinned copper conductor AWG 22/7
INSULATION	Foam-Skin-PE
STRANDING	Two cores stranded together with 2 fillers
SCREEN 1	Aluminium polyester tape
SCREEN 2	Tinned copper wire braid
OUTER SHEATH	LSZH
COLOUR	Violet

PHYSICAL PROPERTIES:

BENDING RADIUS	5 x Ø
NOMINAL OUTER Ø	7.8 ± 0.2 mm
CABLE WEIGHT	70 kg/km
CORE IDENTIFICATION	1. Red 2. Green
PART NUMBER	29996
MARINE TYPE APPROVALS	DNV, LR, RINA

MAIN CHARACTERISTICS:

FIRE PERFORMANCE	IEC 60332-1-2 IEC 60332-3-22
HALOGEN FREE	IEC 60754 series
SMOKE EMISSION	IEC 61034 series
MAXIMUM RESISTANCE CONDUCTOR (LOOP)	≤ 110 Ω/km
CHARACTERISTIC IMPEDANCE	150 Ω ± 10%
MUTUAL CAPACITANCE	30 nF/km
ATTENUATION	9.6 kHz ≤ 2.5 dB/km 38.4 kHz ≤ 4.0 dB/km 4.0 MHz ≤ 22.0 dB/km 16.0 MHz ≤ 42.0 dB/km
OPERATING TEMPERATURE RANGE	-25 °C - 70 °C

Subject to change without prior notice. See latest update on our webpage.

© 2022 Helkama Bica Oy. All rights reserved.



Photo credit: Viking cruises

© 2022 Helkama Bica Oy. All rights reserved.

Subject to change without prior notice. See latest update on our webpage.

helkamabica.com
customer.care@helkamabica.fi
+358 2 410 8700

HELKAMA
THE PERFECT CONNECTION

GENERAL INFORMATION

MATERIALS

INSULATION MATERIALS

XLPE

Cross-linked polyethylene compound.
Excellent mechanical and electrical characteristics

HF90

Low smoke zero halogen flame retardant
Crosslinked polyolefine compound.

SHEATHING MATERIALS

LSZH THERMOPLASTIC

Low smoke zero halogen thermoplastic compound.
Flame retardant and self-extinguishing in the event of fire.

SHF1

LSZH thermoplastic. Low smoke zero halogen thermoplastic compound. Flame retardant and self-extinguishing in the event of fire.

SHF2

Crosslinked thermoset plastic. Low smoke zero halogen cross-linked thermoset oil-resistant compound. Flame retardant and self-extinguishing in the event of fire.

MARKING ON THE SHEATH

Lot number, Cable type, Cable size (number of cores x size of conductors mm²), Voltage, Temperature, Standards, Manufacturer's name, Production month and year, Meter marking.

TESTS AND DEFINITIONS OF TERMS

HALOGEN-FREE

Halogen-free refers to the absence of halogens, such as chlorine and fluorine. Determined on the basis of the halogen content and the acidity of cable's gases.

Halogen-free IEC 60754-series consists of standards IEC 60754-1 and IEC 60754-2.

IEC 60754-1

Determines halogen content of material. Halogen content of material may not exceed 0.5% or 5 mg/g.

IEC 60754-2

Determines degree of acidity of combustion gases. Limit values >4.3 for pH and <10 µS/mm for conductivity.

SMOKE EMISSION

IEC 61034-1, IEC 61034-2

Smoke emission refers to visibility in a fire. Greater light transmittance means better visibility. Smoke Emission IEC 61034-series consists of standards IEC 61034-1 and IEC 61034-2.

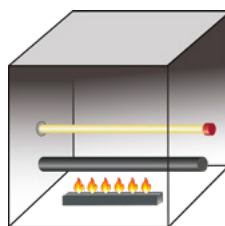

**27 m³ cube
smoke chamber**

Requirements: 60% light transmittance

FIRE PERFORMANCE

IEC 60332-1, IEC 60332-3

Cables must withstand the test specified in IEC standard 60332-3 or IEC 60332-1. Flame-retardant cables do not propagate fire and are self-extinguishing.

IEC 60332-1

Test for single cable. Test procedure and requirements according to picture below.

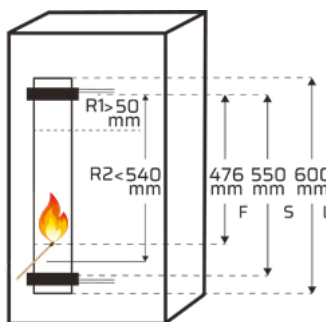

Min. 50 mm of the cable, measured from the upper support, must remain unburned after the specified time.

IEC 60332-3

Test for bunched cables with three categories - A, B and C. Categories are defined by different limits for flammable material and burning times. Cables must extinguish themselves once the burner has been removed.

Test procedure and requirements according to picture below.

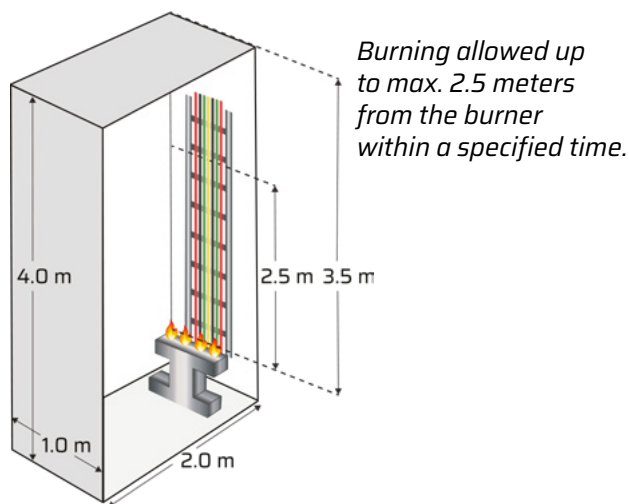

FIRE-RESISTANT

Helkama fire-resistant cables are also flame-retardant.

IEC 60331-25

Test method for fire at a temperature of 750 °C for 180 min. The cable must maintain its function for minimum 180 min with flame and shall remain connected for further 15 minutes without flame (cooling time). During the test the maximum increase in attenuation shall be measured and recorded.

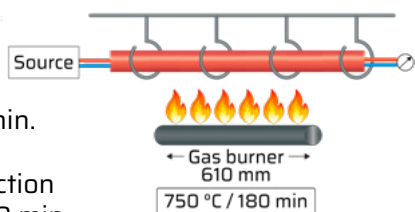

IEC 60331-1

Test method for fire with shock at a temperature of min. 830 °C for 180 minutes for cables with rated voltage up to and including 0.6/1.0 kV, and with Ø > 20 mm.

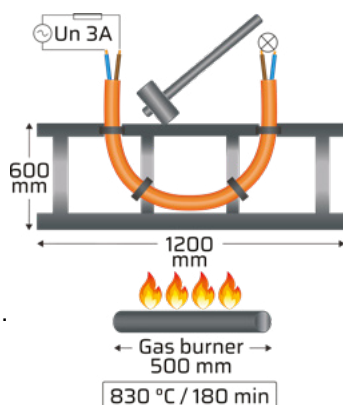

IEC 60331-2

Test method for fire with shock at a temperature of min. 830 °C for 180 minutes for cables with rated voltage up to and including 0.6/1.0 kV, and with Ø < 20 mm.

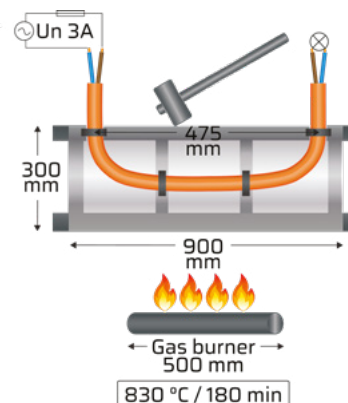

IEC 60331-1 + BS 8491

Based on IEC 60331-1 with adds from BS 8491 Test method for fire with shock at a temperature of min. 830 °C for 180 minutes. For cables with Ø > 20 mm. 5 min before the end of the flame application the water jet is activated and apply a burst of water of 5 s duration. Water burst is repeated until a total of 5 bursts of water been applied.

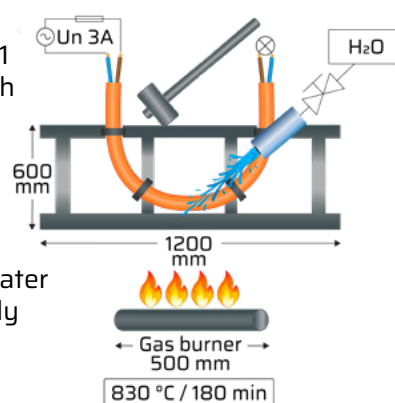

IEC 60331-2 + EN 50200 Annex E

Based on IEC 60331-2 with adds from EN 50200 Annex E Test method for fire with shock at a temperature of min. 830 °C for 180 minutes. For cables with Ø < 20 mm. 15 min before the end of the flame application the water spray is activated and shall spray until the end of flame application time.

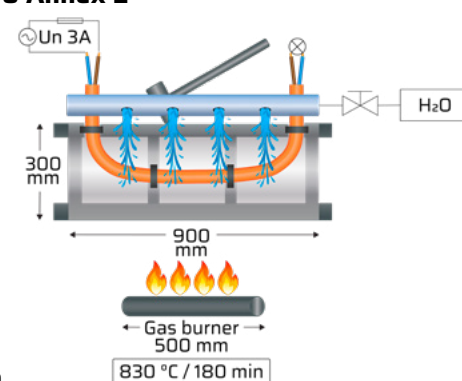

BENDING RADIUS

	LKM-HF LKMM-HF LKEM-HF	During installation During installation Fixed installation Fixed installation	$R = 6 \times \varnothing$ $R = 9 \times \varnothing$ $R = 4 \times \varnothing$ $R = 6 \times \varnothing$	< 25 mm > 25 mm < 25 mm > 25 mm
	LKSM-HF LKMSM-HF LKM-FRHF LKMM-FRHF LKSM-FRHF LKMSM-FRHF RFE-HF, RFE-HF(i) RFE-FRHF, RFE-FRHF(i) RFE-FRHF+WSR/WJR RFE-FRHF(i)+WSR/WJR	During installation Fixed installation	$R = 9 \times \varnothing$ $R = 6 \times \varnothing$	All Diameters
	LKSM-EMC LKSM-EMC-FRHF LKSM-VFD LKAM-HF LKAM-FRHF RFE-EMC-FRHF RFE-EMC-FRHF(i) RFA-HF, RFA-HF(i) RFA-FRHF, RFA-FRHF(i) RFA-FRHF+WSR/WJR RFA-FRHF(i)+WSR/WJR	During installation Fixed installation	$R = 12 \times \varnothing$ $R = 8 \times \varnothing$	All Diameters

DIAMETER TOLERANCE

Nominal outer diameter, mm.	Tolerance	Nominal outer diameter, mm.	Tolerance
1 - 10	±0.5 mm	30.1 - 40	±2.0 mm
10.1 - 20	±1.0 mm	40.1 - 50	±2.5 mm
20.1 - 30	±1.5 mm	50.1 - 60	±3.0 mm

CORE IDENTIFICATION

250 V pair cables	250 V triad cables	250 V quad cables	250 V multicore cables
Pairs numbered a b Pair 1 1 2 Pair 2 3 4 Pair 3 5 6 etc. Each pair white - blue. Pairs numbered 1, 2, 3, 4, 5...	Built up as triple with the following identification Triple white-blue-red	(Quad)cable is built up as a star quad with the following identification 1 core white 2 core blue 3 core white 4 core blue 	2-cores Black numbers on white base 3-cores Black numbers on white base 4-cores to 37-cores Black numbers on white base

0.6/1 kV	Normal type	G-type (with earth conductor)	1.8/3 kV	LKSM-VFD
1-core			1-core	
2-cores			3-cores	
3-cores			3-cores + 3-ground cores	
4-cores				
5-cores				
7-cores and above	 Black numbers on white base	 Black numbers on white base Last core yellow/green.		

BU = Blue, BN = Brown, BK = Black, GY = Grey, Y/G = Yellow/Green

CURRENT RATING

Current rating (A) at an ambient temperature of 45 °C according to standard IEC 60092-352 0.6/1 kV marine cables.

Current carrying capacities in continuous service at maximum rated conductor temperature of 90 °C.

FOR CONTINUOUS SERVICE

Continuous service for a cable is to be considered as a current-carrying service (with constant load) having a duration longer than three times the thermal time constant of the cable, i.e. longer than the critical duration (see short time duty).

Size	N	1	2	3	4	5	7	10	12	14	16	19	24	27	37
1.0 mm ²		18	15	13	13	10	9	8	8	7	7	7	6	6	5
1.5 mm ²		23	20	16	16	13	12	11	10	9	9	9	8	7	7
2.5 mm ²		30	26	21	21	17	16	14	13	12	12	11	11	10	9
4 mm ²		40	34	28	28	23									
6 mm ²		52	44	36	36	30									
10 mm ²		72	61	50	50	42									
16 mm ²		96	82	67	67	56									
25 mm ²		127	108	89	89	74									
35 mm ²		157	133	110	110	91									
50 mm ²		196	167	137	137										
70 mm ²		242	206	169	169										
95 mm ²		293	249	205	205										
120 mm ²		339	288	237	237										
150 mm ²		389	331	272	272										
185 mm ²		444	377	311	311										
240 mm ²		522	444	365	365										
300 mm ²		601	511	421	421										

Correction factors for ambient temperature

Ambient temperature	35 °C	40 °C	45 °C	50 °C	55 °C	60 °C	65 °C	70 °C	75 °C	80 °C
Correction factor	1.10	1.05	1.00	0.94	0.88	0.82	0.74	0.64	0.58	0.47

SHORT CIRCUIT CURRENT

Maximum permissible short circuit current.
0.6/1 kV and 1.8/3 kV 90 °C marine cables.

Based on formula:

$$I_k = 226 \times \frac{S}{\sqrt{t}} \times \sqrt{\ln \frac{234 + T_k}{234 + T_b}}$$

Formula 1:

$$I_k = 146 \times \frac{S}{\sqrt{t}}$$

I_k = Maximum permissible short circuit current.

S = Cross-section of the conductor in mm².

t = Duration of the short circuit in s.

T_k = Maximum rated conductor temperature,

T_b = Maximum rated conductor temperature,
normal, °C

Formula 1: For 0.6/1 kV and 1.8/3 kV cable with XLPE with maximum operating temperature of 90 °C (T_b) and short circuit temperature of 250 °C (T_k).

Cross-section of conductor in mm ²	Duration of short circuit in s.					
	0.2	0.5	1	2	3	10
1.0	0.3	0.2	0.1	0.1	0.1	0.0
1.5	0.5	0.3	0.2	0.2	0.1	0.1
2.5	0.8	0.5	0.4	0.3	0.2	0.1
4	1.3	0.8	0.6	0.4	0.3	0.2
6	2.0	1.2	0.9	0.6	0.5	0.3
10	3.3	2.1	1.5	1.0	0.8	0.5
16	5.2	3.3	2.3	1.7	1.3	0.7
25	8.2	5.2	3.7	2.6	2.1	1.2
35	11.4	7.2	5.1	3.6	3.0	1.6
50	16.3	10.3	7.3	5.2	4.2	2.3
70	22.9	14.5	10.2	7.2	5.9	3.2
95	31.0	19.6	13.9	9.8	8.0	4.4
120	39.2	24.8	17.5	12.4	10.1	5.5
150	49.0	31.0	21.9	15.5	12.6	6.9
185	60.4	38.2	27.0	19.1	15.6	8.5
240	78.4	49.6	35.0	24.8	20.2	11.1
300	97.9	61.9	43.8	31.0	25.3	13.9

Short circuit current in kA

SHORT CIRCUIT FACTOR

Short Circuit Factor can be calculated by following formula:

$$\text{SHORT CIRCUIT FACTOR} = \frac{\text{SHORT CIRCUIT CURRENT}}{\text{CURRENT RATING}}$$

RATED VOLTAGES

Designating the of the rated voltages of cables are **U₀/U (U_m)**, where

U₀ is the rated power-frequency voltage between phase conductor and earth or metallic screen, for which the cable is designed.

U is the rated power-frequency voltage between phase conductors for which the cable is designed.

U_m is the maximum value of the “highest system voltage” for which the cable may be used.

DC For 0,6/1kV cables, the DC voltages, maximum of 1.5 times the AC voltage may be provided so that the voltage to earth does not exceed U_{ODC}.

Cable voltage	AC			DC	
	U ₀	U	U _m	U	U _{ODC}
250 V	150 V	250 V	300 V	375 V	250 V
0.6/1 kV	0.6 kV	1.0 kV	1.2 kV	1.5 kV	0.9 kV
1.8/3 kV	1.8 kV	3.0 kV	3.6 kV	3.0 kV	1.8 kV

TEST VOLTAGES for Routine Tests (RT)

Test voltages specified in standard IEC 60092-350

Rated voltage of cable U ₀ /U, kV	Test voltage for 5 min	
	Alternating current (AC), kV	Direct current (DC), kV
0.15/0.25	1.5	3.6
0.6/1	3.5	8.4
1.8.2003	6.5	15.6

The test voltage shall be increased gradually to the specified value and no breakdown of the insulation shall occur.
HELKAMA uses DC test voltage.

SHORT TIME DUTY

Short time duty according to the standard IEC 60092-352 0.6/1 kV 90 °C marine cables.

If a cable is intended to supply motor or equipment operating for periods of half an hour or one hour, its current rating given in table "current rating", may be increased using the relevant correction factors given by formula:

$$\text{correction factor} = \sqrt{\frac{1.2}{1-\exp(-t_s/T)}}$$

(t_s = service time, min.)

T = Time constant, min.)

$$T = 0.245 \times \varnothing^{1.35}$$

(\varnothing = Overall diameter of the cable, mm.)

Ø of the cable, mm.	Service time		T, Time constant, min.	3 x T Critical duration, min.
	30 min.	60 min.		
1	1.058	1.058	0.245	0.735
2	1.058	1.058	0.625	1.87
3	1.058	1.058	1.08	3.24
4	1.058	1.058	1.59	4.78
5	1.058	1.058	2.15	6.46
6	1.058	1.058	2.75	8.26
7	1.058	1.058	3.39	10.2
8	1.059	1.058	4.06	12.2
9	1.059	1.058	4.76	14.3
10	1.061	1.058	5.48	16.5
20	1.126	1.066	14.0	41.9
30	1.255	1.105	24.2	72.5
40	1.403	1.173	35.6	107
50	1.554	1.254	48.2	145
60	1.705	1.341	61.6	185
Correction factor.				

INTERMITTENT SERVICE

Correction factor for intermittent service according to the standard IEC 60092-352

The correction factor given hereby has been roughly calculated for periods of 10 min, of which 4 min are with constant load and 6 min without load.

Intermittence period = 10 min.

Intermittence ratio = 40%.

$$F_i = \sqrt{\frac{1-\exp(-10/T)}{1-\exp(-4/T)}}$$

Ø of the cable, mm.	Correction factor.
1	1.000
2	1.001
3	1.012
4	1.042
5	1.083
6	1.127
7	1.170
8	1.208
9	1.242
10	1.273
20	1.433
30	1.490
40	1.518
50	1.534
60	1.544

VOLTAGE DROP

Cable types: All 0.6/1 kV and 1.8/3.0 kV cables

Size	Resistance at 20 °C ohm/km	Resistance at 90 °C ohm/km	Voltage reduction mV/Am*)	Resistance at 45 °C ohm/km	Current rating A**)	Voltage reduction V/m***)
1.0 mm ²	18.1	23.1	46.2	19.9	18	0.72
1.5 mm ²	12.1	15.4	30.9	13.3	23	0.61
2.5 mm ²	7.41	9.45	18.9	8.14	30	0.49
4 mm ²	4.61	5.88	11.8	5.06	40	0.41
6 mm ²	3.08	3.93	7.85	3.38	52	0.35
10 mm ²	1.83	2.33	4.67	2.01	72	0.29
16 mm ²	1.15	1.47	2.93	1.26	96	0.24
25 mm ²	0.727	0.927	1.85	0.798	127	0.20
35 mm ²	0.524	0.668	1.34	0.575	157	0.18
50 mm ²	0.387	0.493	0.987	0.425	196	0.17
70 mm ²	0.268	0.342	0.683	0.294	242	0.14
95 mm ²	0.193	0.246	0.492	0.212	293	0.12
120 mm ²	0.153	0.195	0.390	0.168	339	0.11
150 mm ²	0.124	0.158	0.316	0.136	389	0.11
185 mm ²	0.0991	0.1264	0.253	0.1088	444	0.097
240 mm ²	0.0754	0.0961	0.192	0.0828	522	0.086
300 mm ²	0.0601	0.0766	0.153	0.0660	601	0.079

*) at +90 °C

***) For continuous service (single core, ambient temperature +45 °C)

****) at maximum current rating for continuous service at +45 °C

Cable types: LKSM-HF 250V, RFE-HF, RFE-HF(i), RFA-HF, RFA-HF(i), RFE-FRHF, RFE-FRHF(i), RFA-FRHF, RFA-FRHF(i)

Size	Resistance at 20 °C ohm/km	Maximum conductor temperature, °C	Resistance at 45 °C ohm/km	Voltage reduction mV/Am at 45 °C*)	Resistance at 90 °C ohm/km	Voltage reduction mV/Am at 90 °C*)
0.5 mm ²	40.4	90	44.4	88.7	51.5	103.0
0.75 mm ²	26.0	90	28.6	57.1	33.2	66.3
1.5 mm ²	12.8	90	14.1	28.1	16.3	32.6

*) at +90 °C

***) For continuous service (single core, ambient temperature +45 °C)

****) at maximum current rating for continuous service at +45 °C

PE-RULES

PE-Rules according to the standard IEC 60092-352. Table shows how to determinate sizes of earth continuity conductors and equipment earthing connections.

Arrangement of earth conductor	Cross-section area of main current carrying conductor	Minimum cross-section area of earth conductor
Insulated yellow/green earth conductor in cable	$Q \leq 16 \text{ mm}^2$	Q
	25 mm^2	16 mm^2
	$Q \geq 35 \text{ mm}^2$	50 % of Q
Insulated yellow/green earth conductor in cable split into three separate.	$Q \leq 16 \text{ mm}^2$	3 pcs $Q/3$
	25 mm^2	3 pcs 6 mm^2
	$Q \geq 35 \text{ mm}^2$	50 % of Q
Use copper wire braid armour, e.g. LKSM- type cables	$Q \leq 16 \text{ mm}^2$	Q
	25 mm^2	16 mm^2
	$Q \geq 35 \text{ mm}^2$	50 % of Q
"Separately installed earth conductor for fixed installation, e.g. LKEM-HF 0.6/1 kV yellow/green coloured."	$2.5 < Q < 120 \text{ mm}^2$	50 % of Q, minimum 4 mm^2
	$Q \geq 120 \text{ mm}^2$	70 mm^2

Q= Cross-section area of main current carrying conductor

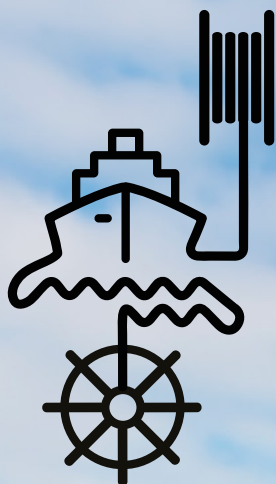

HELKAMA BICA OY

Lakimiehenkatu 4
FI-20780 KAARINA, FINLAND
(Turku area)

Lasitehtaankatu 12
FI-10960 HANKO, FINLAND

Tel- +358 2 410 8700
customer.care@helkamabica.fi

helkamabica.com

HELKAMA BICA (Shanghai) Co., Ltd.

Plot 1-2, Minghang EPZ
No. 3111 Huan Cheng
West Road
Fengxian Distr.
Shanghai 201401, China

Tel. +86 21 3365 5333
sales@helkamabica.cn

2022

HELKAMA

THE PERFECT CONNECTION